



[www.vortice.ltd.uk](http://www.vortice.ltd.uk)



**VORT QBK SAL KC RANGE**

COMMERCIAL VENTILATION



## HEADQUARTERS



*Our current Vortice Headquarters have been located in Tribiano (Milan) since 1972.*

Vortice main company's philosophy is the concept that "air is our life". Our mission is always to provide effective solutions for improved air quality using the latest technology to develop and manufacture effective products worldwide.

Vortice has achieved European market leadership by dedicating their efforts to the production of products for ventilation, climate control, heating, extraction, purification and the treatment of air, for domestic, commercial and industrial applications. Since 1954 Vortice has been synonymous with quality and excellence and continues to make significant improvements by investing in continuous research to improve the efficiency and quality of its products.



## VORTICE IN THE WORLD



Founded in 1974, Vortice France is located at Crétail about 10 Km from Paris.



Founded in 1977, Vortice Limited is located at Burton upon Trent in the East Midlands.



Founded in 2012, Vortice Ventilation System is located about 200 Km from Shanghai.



Founded in 2012, Vortice Latam in San José Costa Rica.

## VORT QBK - SAL KC RANGE

Commercial kitchen fan for ducting from canopies

LONG LIFE 30.000 h



- Continuous Operation
- Flexible installation with choice of discharge position (left or right)
- Suitable for external installation with optional rain cover
- Capable of extracting hot fumes up to 100 °C
- Motor located outside of the airstream
- Backward curved centrifugal impeller
- Supplied with integral drain tray and drain point
- Robust self supporting frame construction with 23.5mm thick insulated double skin galvanised steel panels
- Single phase and three phase models available
- 8 models - 5 diameters
- Accessories available: Mounting feet, anti vibration dampers, external rain cover, angled discharge section, circular discharge adaptor
- Controllers available



*drain for condensate /  
residues*

Fans used in VORT QBK SAL-KC range comply with ErP N° 327/2011/UE.



TECHNICAL DATA

Models	Code	V - 50 Hz	W		A		Poles	RPM	Max Airflow		Max Pressure		°C Max	°C Ariflow	IP motor	Kg					
			nom/max	nom/max	m³/h	l/s			mmH <sub>2</sub> O	Pa											
VORT QBK - SAL KC M 315	45266	220 - 240	275 280	1.30 1.23	4	1365	1790	497	36.1	354	70	120	55			33					
VORT QBK - SAL KC M 355	45268		770 820	3.52 3.41												1355	4300	1194	46.3	454	50
VORT QBK - SAL KC M 400	45276		1130 1190	5.19 4.97												1325	6300	1750	59.2	582	60
VORT QBK - SAL KC T 315	45267	380 - 415	270 280	0.58 0.61	4	1420	1860	516	37.5	367	70	120	55			33					
VORT QBK - SAL KC T 355	45269		790 805	1.47 1.53												4420	1227	50.0	490	50	
VORT QBK - SAL KC T 400	45277		1225 1295	2.24 2.22												1390	6500	1805	63.7	625	68
VORT QBK - SAL KC T 500	45278		2090 2180	3.65 3.55												1325	9000	2500	79.5	780	80
VORT QBK - SAL KC T 560	45279		3520 3630	6.85 6.87												6	950	16300	4500	80.0	785

SOUND LEVELS

Models	Code	Speed	125 Hz	250 Hz	500 Hz	1000 Hz	2000 Hz	4000 Hz	8000 Hz	Lw dB (A)	Lp dB (A) 3m*
VORT QBK - SAL KC M 315	45266	Max	56.8	55.4	60.9	60.4	57.6	50.6	45.1	70.2	49.7
VORT QBK - SAL KC M 355	45268		67.1	63.7	68.5	65.8	63.6	60.6	53.4	77.8	57.3
VORT QBK - SAL KC M 400	45276		68.2	61.9	66.1	71.9	66.9	60.6	56.4	80.6	60.1
VORT QBK - SAL KC T 315	45267		55.8	55.5	61.3	60.8	58.3	51.6	45.6	70.9	50.4
VORT QBK - SAL KC T 355	45269		67.1	64.2	69.7	67.5	64.6	61.7	54.4	79.6	59.1
VORT QBK - SAL KC T 400	45277		68.8	62.1	67.3	71.9	68.1	61.1	57.0	82.9	62.4
VORT QBK - SAL KC T 500	45278		76.2	67.4	72.2	72.7	70.6	64.8	59.1	84.2	63.7
VORT QBK - SAL KC T 560	45279		60.5	68.8	73.0	76.9	78.8	67.4	61.6	86.2	65.7

\* Sound pressure level measured at 3 m in free field conditions with long-cased appliance in delivery mode, in accordance with standard EN ISO 3741.

DIMENSIONS

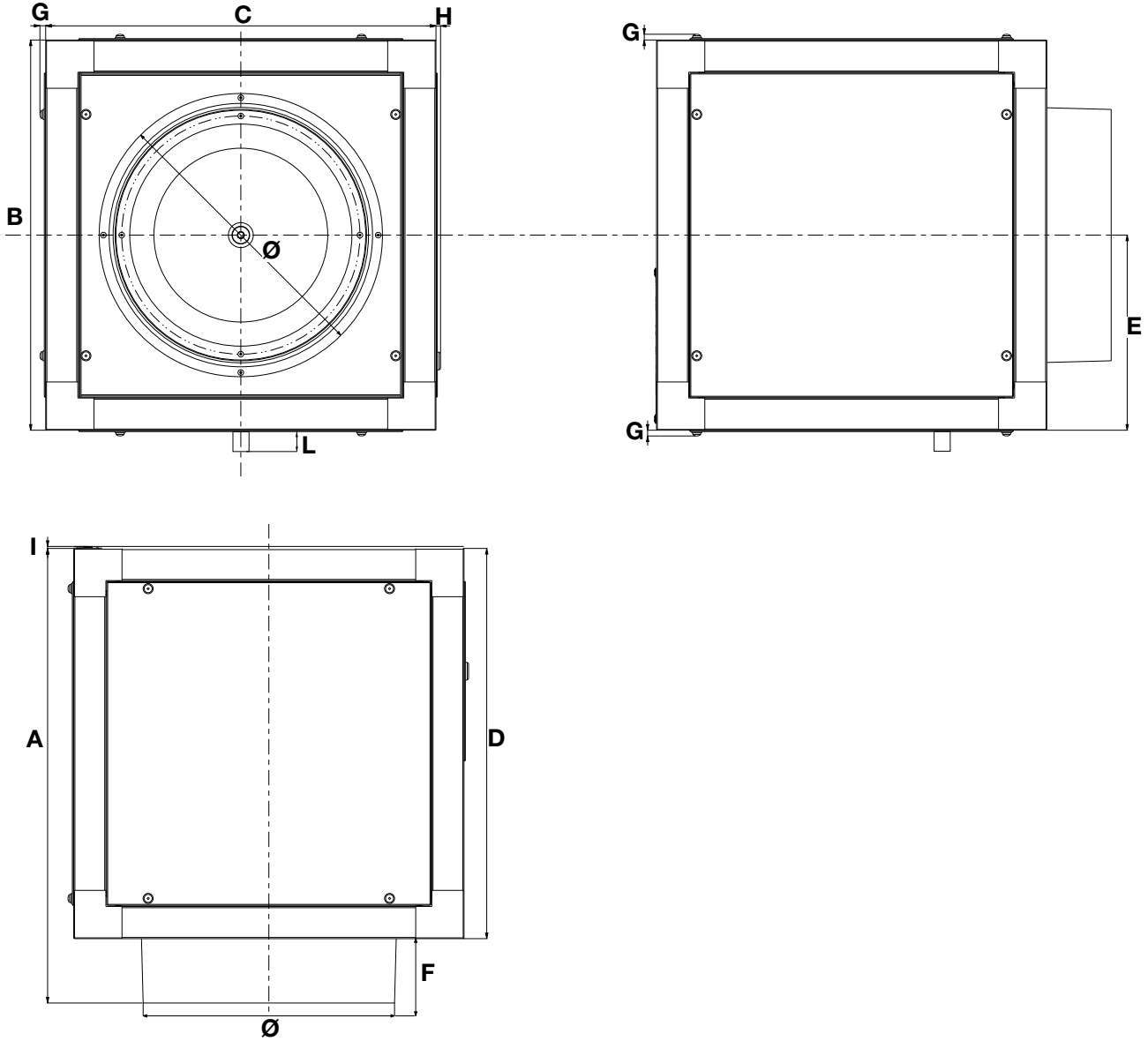

Models	A	B	C	D	E	F	G	H	I	L	Ø
VORT QBK - SAL KC 315	566		485		242.5						315
VORT QBK - SAL KC 355	671		590		295						355
VORT QBK - SAL KC 400	731		650		325	81	8	6	3	26	400
VORT QBK - SAL KC 500	803		722		361						500
VORT QBK - SAL KC 560	1092		1011		505.5						560



# PERFORMANCE CURVES

— Delivery — Power consumption

### VORT QBK - SAL KC M 315

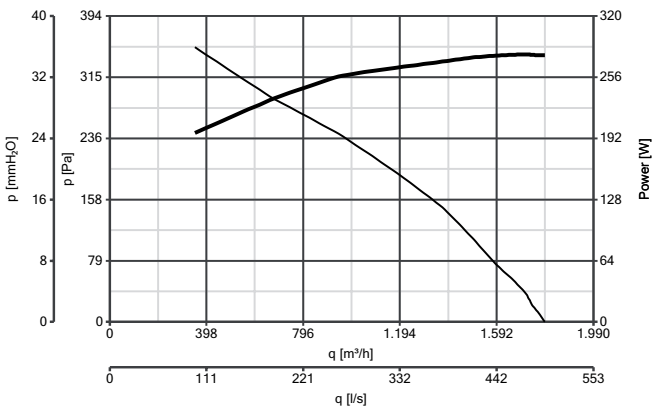

### VORT QBK - SAL KC M 355

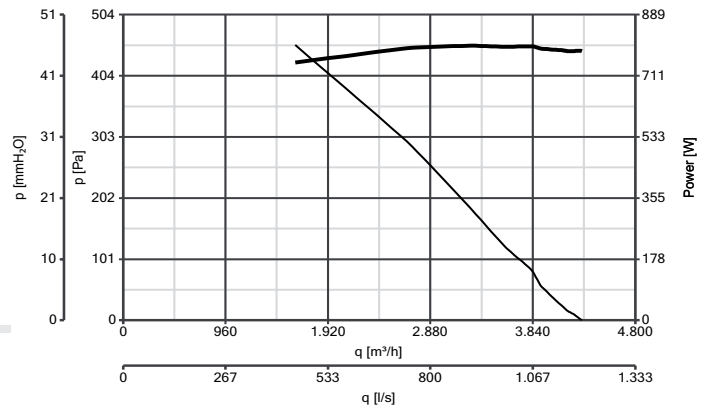

### VORT QBK - SAL KC M 400

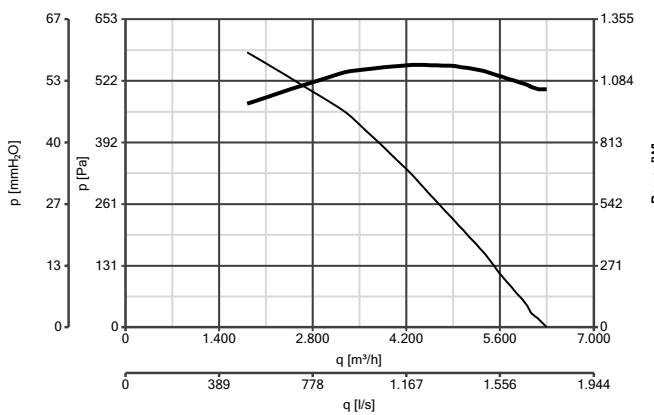

### VORT QBK - SAL KC T 315

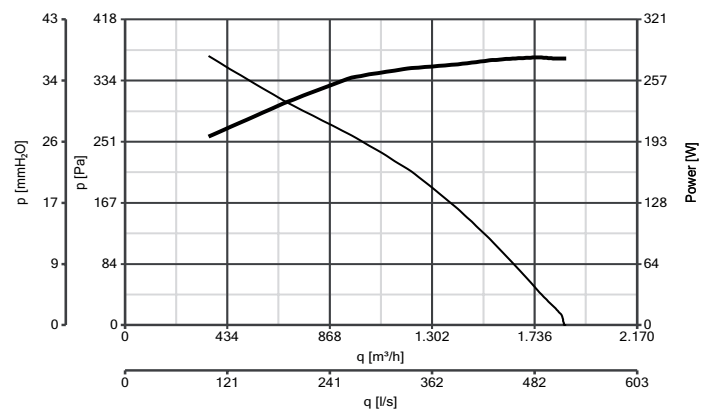

### VORT QBK - SAL KC T 355

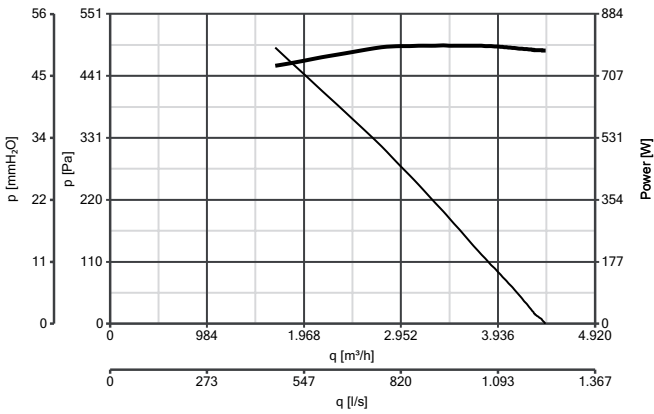

### VORT QBK - SAL KC T 400

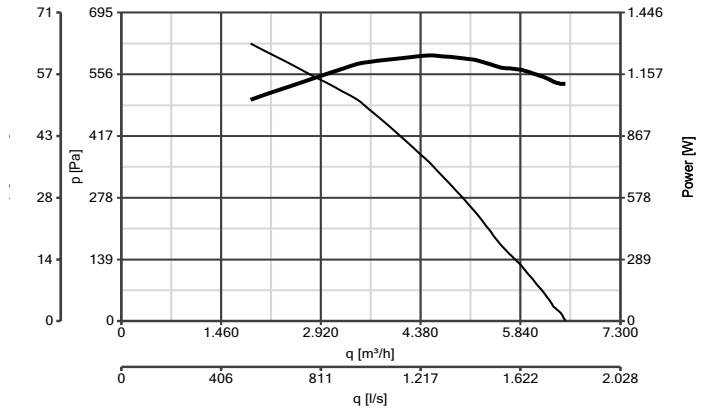

### VORT QBK - SAL KC T 500

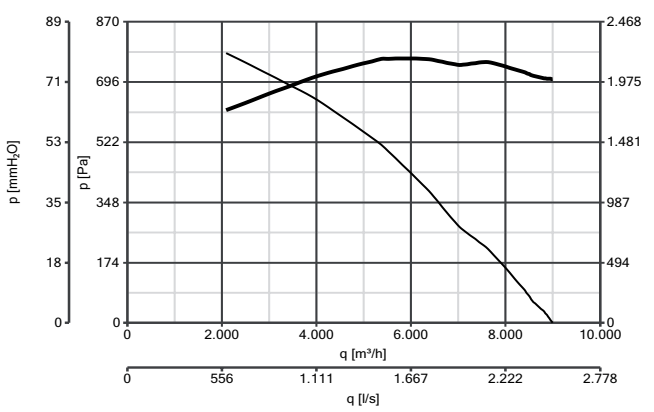

### VORT QBK - SAL KC T 560

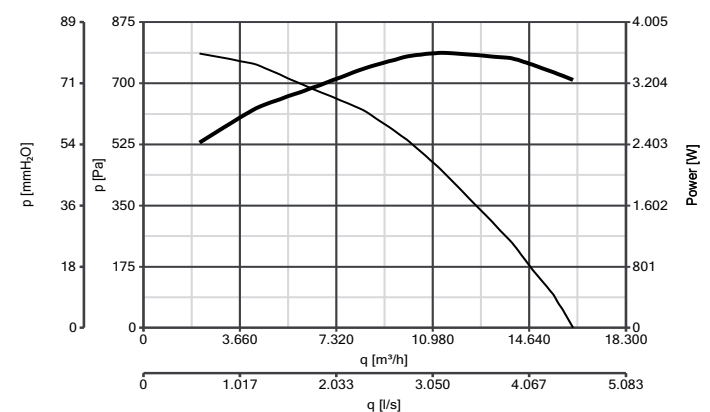



ACCESSORIES

	Description	Code	Product	
	IREM 3 - Single-phase speed controller	12931	45266	
	IREM 5 - Single-phase speed controller	12932	45268	
	IRET 6 - Three-phase speed controller	12934	45277	
	IRM 40 - Three position single phase speed controller	12922	45266	
	IRM 50 - Three position single phase speed controller	12928	45268	
	IRT 35 - Three phase variable voltage drive	12924	45267 - 45269	
	IRT 40 - Three position three phase speed controller	12927	45277 - 45278	
	IREM INVERTER 4M - Single phase speed controller	12815	45266	
	IREM INVERTER 6M - Single phase speed controller	12818	45268 - 45276	
	IRET INVERTER 2.5M - Three phase speed controller	12816	45267 - 45269	
	IRET INVERTER 5M - Three phase speed controller	12817	45277 - 45278	
	IRET INVERTER 8M - Three phase speed controller	12821	45279	
	POTENTIOMETER	12819	12815 - 12816 - 12817 - 12818	
	Circular discharger adaptor	315	24184	45266 - 45267
		355	24185	45268 - 45269
		400	24186	45276 - 45277
		500	24187	45278
		560	24135	45279
	Angled discharge section	315	24196	45266 - 45267
		355	24197	45268 - 45269
		400	24198	45276 - 45277
		500	24199	45278
		560	24138	45279
	External Rain Cover	315	24192	45266 - 45267
		355	24193	45268 - 45269
		400	24194	45276 - 45277
		500	24195	45278
		560	24137	45279
	Anti Vibration Dampers	315/355	24188	45266 - 45267 - 45268 - 45269
		400/500/560	24191	45276 - 45277 - 45278 - 45279
	Mounting Feet	24204	45266 - 45269 - 45276 - 615277	

Cod. 5.170.084.994 UK

12/15

Vortice Elettrosociali S.p.A  
Strada Cerca, 2  
Frazione di Zoate  
20067 Tribiano (Milano)  
Tel. (+39) 02 906991  
Fax (+39) 02 90699314  
Italia  
[www.vortice.com](http://www.vortice.com)  
[export@vortice-italy.com](mailto:export@vortice-italy.com)

Vortice France  
15-33, Rue Le Corbusier  
CS 30007  
94046 Créteil Cedex  
Tél. (+33) 1.55.12.50.00  
Fax (+33) 1.55.12.50.01  
France  
[www.vortice-france.com](http://www.vortice-france.com)  
[contact@vortice-france.com](mailto:contact@vortice-france.com)

Vortice Limited  
Beeches House, Eastern Avenue  
Burton upon Trent  
DE13 0BB  
United Kingdom  
Tel. (+44) 1283 492949  
Fax (+44) 1283-544121  
[www.vortice.ltd.uk](http://www.vortice.ltd.uk)  
[sales@vortice.ltd.uk](mailto:sales@vortice.ltd.uk)

