

Air handling unit



Introduction of PAYA TAHVIEH activities in the field of air conditioning:

A) Consulting and Designing:

- 1) visit the site and determine the type of air conditioning system.
- 2) Design the structure and the internal parts of equipment by technical software.
- 3) Design the ducting system.

B) Manufacturing:

PAYA TAHVIEH air conditioning products are designed to a high engineering standard to provide the requirements of heating, cooling, de-humidification, filtration and air distribution to a conditioned space.

PAYA TAHVIEH air conditioning products include: horizontal, vertical, L-type and multi-zone packaged unit and air handling unit, air washer, ducted fan coil, Evaporative cooler and cooling tower.

C) Installation:

We pride ourselves on working closely with our customer at every stage of the installation, while the latest project management methods and an expert team guarantee the customer satisfaction.

D) Testing and Validation

Our test facilities (include: measurement of flow rate, pressure, particle counting, temperature, humidity, sound and ...) enable us to offer a flexible approach to design of the right solution according to the relevant standards.

C) Mission

'Air conditioning and minimize the particles of the environment to meet a part of customer's needs'.

Nomenclature

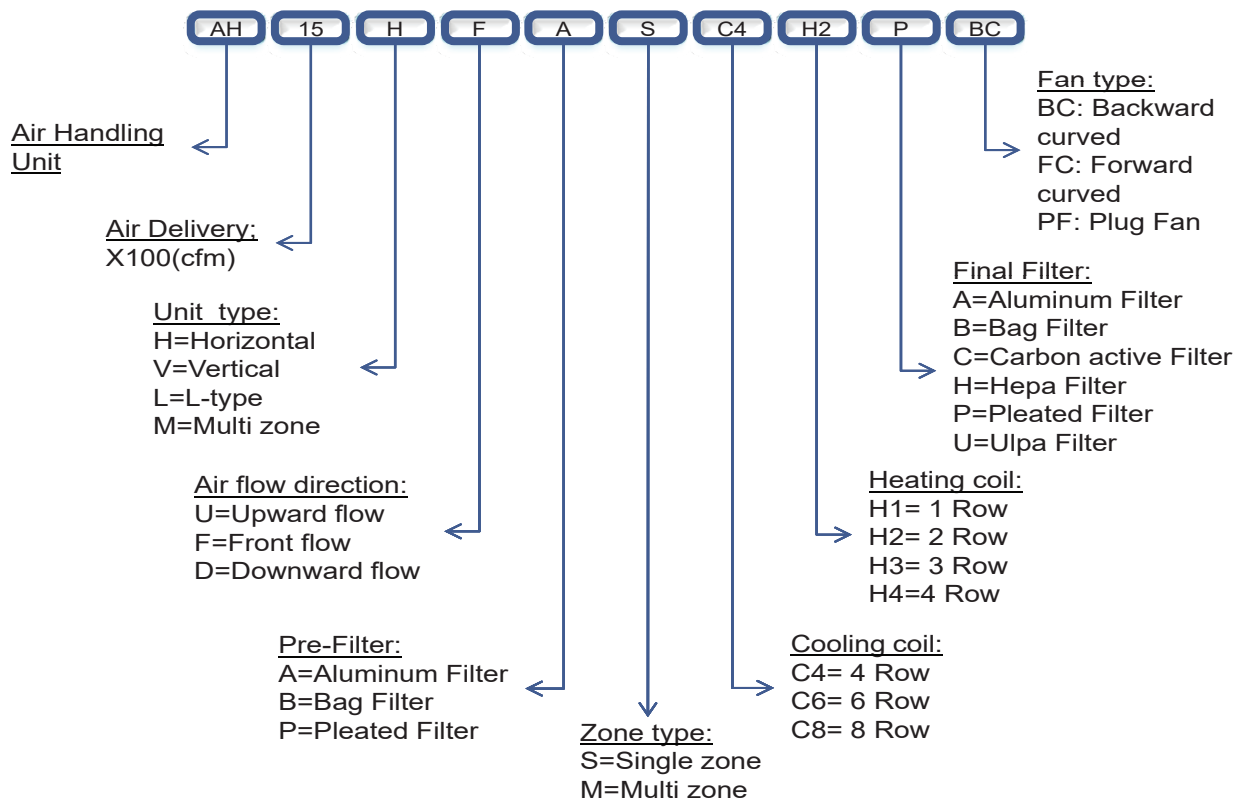

Content

Introduction.....	1	Control Elements.....	7
General Features.....	1	Optional Accessories.....	8
Component Features.....	1	Design AHU by Software.....	9
Sections & Sub Assemblies.....	2	Selection Guide	11
Units for Outdoor Installation.....	4	Technical Specifications	12
Accessories & Options	4	Design Fan Software.....	18
Fan & Motor.....	5	Dimensions.....	22
Filters	6		

Legend

The following legends are used throughout this manual:

V	Volts
cfm.....	Cubic feet per minute
DBT	Dry Bulb Temperature
EAT	Entering Air Temperature
ESP.....	External Static Pressure
EWT.....	Entering Water Temp
FPI.....	Fins per inch
fpm.....	Feet per minute
gpm.....	Gallons per minute
inwg.....	inches of Water Gauge
Hz	Hertz
KW.....	Kilowatts

Kg	Kilograms
KPa.....	Kilo Pascals
lbs.....	Pounds weight
LWT	Leaving Water Temp.
MBH.....	1000 Btuh
m/s.....	Meters per second
OD	Outside Diameter
Pa	Pascals
Ph	Phase
psig.....	pounds per sq.inch
rpm	revolutions per minute
SST.....	Saturated Suction Temp.
WBT.....	Wet Bulb Temperature

Introduction

PAYA TAHVIEH Air Handling Units are designed to a high engineering standard to provide the requirements of ventilation, heating, cooling, de-humidification, filtration and air distribution to a conditioned space.

PAYA TAHVIEH AHUs are available in 15 sizes to deliver from 2500 cfm to 45,000 cfm nominal air flow rate against total static pressure up to 8 in.w.g. Our AHUs are applicable for indoor and outdoor installation and they are ideal for large halls, schools, offices, banks, workshops, laboratories, restaurants, cinemas, hospitals, departmental stores, clean rooms, mosques and super markets, etc.

designed to meet the Indoor air quality requirements as per ARI standard 62.

General Features

our AHUs are manufactured in modular sections. Units can be shipped fully or partially assembled to facilitate handling and lifting in case of limited access. All components of AHUs are easily accessible. Different sectional arrangements & fan discharge positions are possible depending on the site constraints and requirements. Air handling units are suitable both for duct connection or free discharge applications. A typical Air Handling Unit consists of a wide choice of a combination but not limited to the following sections: fan, cooling coil, heating coil, humidifier, filter section, heat recovery system, by-pass section, multi-zone, and mixing box dampers, return air fan, plenums etc.

Component Features

Casing & Construction

Frame

Casings are constructed of framed modules for maximum rigidity and strength. Structure frame is made of hot dip coated galvanized steel profile, which has excellent mechanical characteristics. The cross section of this profile is specially designed for this type of applications.

Profiles are connected by means of special corner pieces. This frame construction gives the possibility of completely dismantling the unit sections and re-assembly at site in case of difficult access.

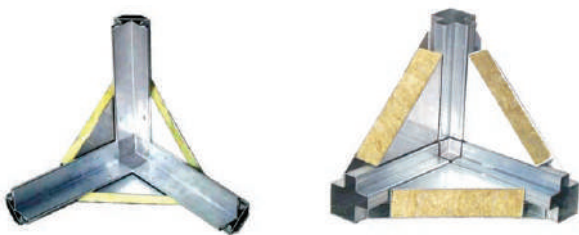

Access and fixed panels are constructed of hot dip galvanized steel conforming to JIS-G 3302 and ASTM-A-653. Access panels are provided with quick release

fasteners to facilitate access to all internal components for maintenance and service. Suitable handles are provided for ease of handling.

All fixed panels are bolted to the frame and provided with special gasket between panels and frames to ensure air tightness. This bolted construction makes all sections accessible from both sides.



Internal skin

Inner panel skin is made of galvanized steel, is easy to clean and has smooth surface. This eliminates any chance of dirt and bacteria accumulation, making double skin units ideally suitable for hygienic applications, such as, pharmaceutical industries, hospitals, operation theatres and food processing industries, etc. Stainless steel inner skin or perforated inner skin or aluminum inner skin for better sound absorption characteristics is available as an option.



Insulation

For best thermal and acoustical performance, all panels and frames are internally insulated with polyethylene. The following are the optional insulation materials available in the AHUs:

- 2" fiber glass insulation with the same specifications as standard.
- 1" or 2" polyurethane foam injection or board with density in the range of 2 to 3 lb./ft³ (32 to 48 kg/m³) and thermal conductivity of 0.16 BTU.in/ft².°F. h (0.023 W/m²K). The injection is only possible for double skin units.

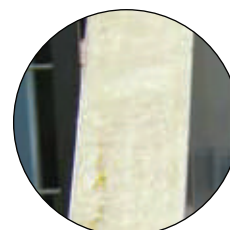

Major Sections & Sub-Assemblies

PAYA TAHVIEH AHUs are constructed of suitable sized casing module and following sub-assemblies:

Fan Section

Fan

Fans and blowers are individually selected to match external static pressure, sound, efficiency, and space design criteria as specified. Double inlet double width centrifugal fans and Plug fans are standard supply in PAYA TAHVIEH AHUs. The impellers can have forward curved or, backward inclined depending on the requirements. The impellers are keyed to the shafts. All fans are statically and dynamically balanced.

OUR fans use self - aligned ball or pillow block bearings that are greased for life. Pillow block bearings are provided with re-greasing fittings. Fans are selected for best sound characteristics based on maximum fan efficiency. Different fan positions are available depending on the requirement. Refer to dimensional data for details.

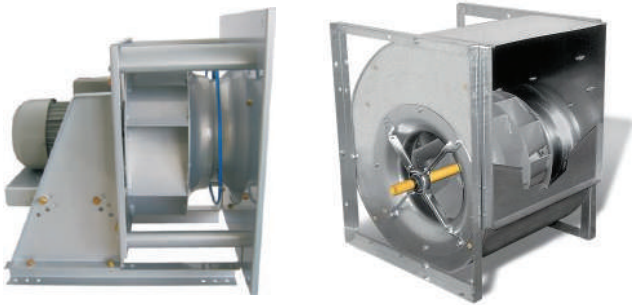

Motors

Fan motors are totally enclosed fan cooled, foot mounted, 4 poles, IP54 & IP-55 protected and Class-F insulated. The motor is mounted on adjustable base, so that belt tension can be easily adjusted. The complete fan motor drive assembly is mounted on floating sub base, In order to limit transmission of noise and vibration the complete fan motor sub-base assembly is mounted on anti-vibration mounts and, therefore, it is not necessary to install external vibration mounts. Flexible connection is provided between fan discharge and casing panel to avoid transmission of vibration to the connecting duct.

Motors can be provided on either right or left hand side facing the unit from return air side. Section is sized to accommodate different motor sizes depending on the actual requirement of airflow and static pressure.

Options

- Non-standard fan size.
- Spark proof fans.
- Explosion proof motor.
- Variable speed drives (Frequency Inverter).
- Stainless steel shaft.
- Extended lubrication fittings.
- Standby motor (additional) with manual change

over.



Coil Section

Headers are made out of seamless copper pipe. The headers joints are extruded to provide large bearing surface for maximum strength. Air vents and drain plugs are standard for water coils. Coils can be provided with moisture eliminator depending on the air conditions. Eliminator blades are made of PVC, with shape specially designed to trap water droplets blown off the coil. Please specify for chilled water and DX coils with eliminator, respectively. Cooling coil section is provided with insulated drain pan with drain connection, in order to hold and remove the condensate formed during dehumidification.

Variety of coils including chilled water, direct expansion, hot water and steam are available to meet a wide range of application requirements. Coils are assembled in slide-in guides for easy removal for maintenance or replacement. Coils are constructed from seamless copper tubes of 3/8" OD for sizes 250-750 and 5/8" OD for sizes 750-4500, arranged in a staggered form in the direction of airflow.

Copper tubes are mechanically expanded into continuous corrugated aluminum fins, available in 8 FPI, 10 FPI and 14 FPI fin spacing to provide continuous compression bond over the entire finned length for maximum heat transfer rates.



Coil Circuiting and Handing

Water coils can be provided with various coils circuiting like half, full or double depending on the water flow rate and water pressure drop through the coil.

Direct expansion coils are equipped with a properly sized distributor to ensure equal refrigerant fed to all circuits. The number of circuits is chosen to provide optimum heat transfer and reasonable refrigerant velocity and pressure drop so as not to trap any oil in the coil tubing. Coil connections can be provided on

either right or left hand side facing the unit from return air side. Drain connection can be provided on either side or on both sides as required. Inlet and outlet connections are sealed against unit panel by means of flexible closed cell gaskets. PAYA TAHVIEH provides sweat connections for coils as standard.

Electric Heater Section

Two different types of electric heater element batteries are available:

Open Type: constructed from 80/20 nickel chrome resistance elements.

Finned Type: constructed from 80/20 nickel chrome resistance wire centered in stainless steel sheath metal tubes by compressed magnesium oxide.

Electric heater batteries are available in a wide range of capacity (KW) and steps. Electric heater batteries are supplied with primary and secondary manual safety cutouts, as standard. Batteries other than this can be supplied upon request.

Electric heater capacity in KW can be calculated in IP system as:

$$Capacity (KW) = 1.085 \times Airflow Rate (cfm) \times Air Temperature Rise (°F)/3412$$

Or in SI system as:

$$Capacity (KW) = 1.21 \times Airflow Rate (l/s) \times Air Temperature Rise (°C)/1000.$$

Humidifier Section

Various types of humidifiers are available depending on application:

-Steam humidifiers: Humidity is added in the form of steam. Two types of external and internal steam humidifiers are available

-Evaporative Type: This type consists of evaporative flooded fill media. The air passing through the evaporative media is humidified and cooled due to intensive contact between air and the wetted & unheated contact surface. The increase in humidity ratio occurs through water evaporation, as air passes through media.



-Spray Pad Type: In this type, water is sprayed over the pad area. Air is humidified and cooled as it passes through the wetted pad media.



Dampers

PAYA TAHVIEH units are equipped with multi blade, low leakage, and heavy duty dampers to control the air flow rate by introducing resistance to air flow in the system. Dampers are available with parallel blades and opposed blades. Links are provided for either manual or motorized operation. The following dampers are available:

- Full face air intake damper
- Face & bypass damper
- Fresh, exhaust and return air damper for mixing box and economizer control

The damper frame is constructed from galvanized steel, blades from galvanized steel, shafts from steel, bearing from bronze and linkage and brackets from galvanized steel. Aluminum damper blades in airfoil profile are available, as an option.



Sound Attenuator Section

Sound attenuator can be provided in both supply and return air side. The standard design is with vertical specially designed splitters consisting of sound absorbing material parallel to the air stream matching unit cross section. Two different media depths of 24” and 48” are available as standard.

A variety of splitter material, thickness, length, spacing and casing are available in order to satisfy even the most strict sound attenuation requirements.



Mixing Box Section

Mixing box with fresh air and return air dampers are available to mix the outside fresh air with recalculated return air. Both the return and fresh air dampers are sized to handle 0-100% of the total supply air. Combination of mixing box and panel filter can be provided in one section, if required.

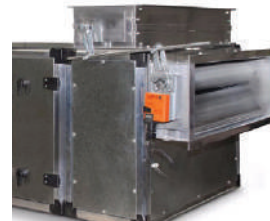

Exhaust Box Section

Exhaust box with exhaust air dampers are available. When used in combination with mixing box with motorized dampers, it provides excellent economizer control.

Plenum Sections

Empty plenums can be supplied either for future use or for particular applications like access, end vertical assembly, end bottom plenum for bottom return air applications, etc. Standard sizes are listed in the dimensional data.

Plenums are available in three different sizes of 18", 24", and 36" depth. Custom sizes to suite a particular requirement can be supplied as an option.

Multi-zone & Dual-duct Sections

PAYA TAHVIEH AHUs can be designed to incorporate blow through multi-zone section complete with cooling/heating (if required) coils and mechanically interlocked dampers.

Vertical and horizontal discharge arrangements are also available. A blow through dual duct can be provided to meet the required.



Heat Recovery Section

In order to conserve the energy consumption by exchanging energy between the supply and exhaust air streams, various types of heat recovery systems can be provided as an integral part of the units.



These depend upon special installation and other requirements like:

• **Run around Coil System:** This system comprises of two coils placed in the supply and exhaust air streams. The coils are to be connected in a closed loop via piping and circulating pump (supplied by others). Water or glycol is circulated as a heat transfer medium.

This system offers efficiency up to 65% and recovers sensible heat only.

• **Fixed Plate Heat Recovery System:**

Fixed plate heat recovery system consists of fixed aluminum plates separating the exhaust and supply air streams. The exhaust air passes through the exchanger from end to end and the supply air stream passes through in a counter flow. The two air streams are totally segregated and flow through individual passages formed by the plates within the exchanger. The plates separating the two air streams act as the heat transfer medium. This system offers efficiency up to 70% and recovers sensible heat only.

• **Rotary Heat Recovery System (Thermal Wheel):**

Heat Wheels are revolving cylinders consisting of an air-permeable matrix with large interior surface. The matrix is cooled as cold air is passed through the wheel. This in turn cools the fresh air stream when the cooled rotating matrix comes in line with the supply air stream. When sprayed with a hygroscopic coating, the heat wheel will transfer moisture from the fresh air stream to the exhaust stream. Heat Wheel offers are capable of recovering both sensible and latent heats and offer efficiencies as high as 85%. Heat wheels are ideal for applications that demand high percentage of fresh air intake like in hospitals, research labs, schools and pharmaceutical companies.

PAYA TAHVIEH AHUs for Outdoor Installation

For outdoor installations PAYA TAHVIEH provides various options to protect the unit from varying climates. These include:

- Weather proof top cover to protect against rain.
- 2" thick panels to prevent cold bridges.
- Air Intake Louver to prevent foreign material to enter the unit in fresh air intake.
- Sand trap louver to extract coarse sand prior to the entry in the unit.
- Rain hood to prevent rain entering the fresh air intake.
- Bird screen to prevent foreign material to enter the unit in fresh air intake.

Accessories and Options

In order to meet most application requirements, PAYA TAHVIEH units can be supplied with various accessories and options, such as:

- Stainless steel construction.
- Bulk Head Light Fittings.
- Stainless Steel Fasteners.
- Hinged Access doors with latches.
- Differential Air Pressure Switch.
- Manometers to monitor air pressure drop across filters can be supplied for field installation.
- Walkway can be provided in the desired section for ease of maintenance.
- External Vibration Isolators can be supplied loose for site installation

Fan and motor arrangement

When evaluating the merits of each fan type, consider the application’s volumetric rate of airflow, static pressure, required sound characteristics, cost, as well as the nature of the motor load and how the occupied space is used. Fan and fan motor may be oriented in the fan segments as shown. Consideration must be given to which orientation is used where. Upstream/downstream images shown below.

Motor arrangement

Motor beside

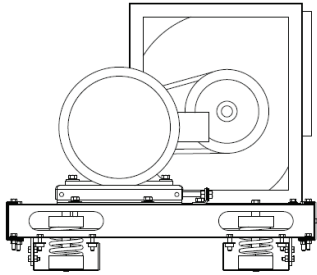

Motor behind

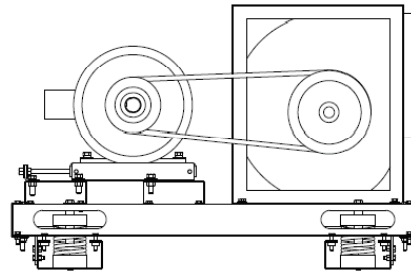

Double inlet centrifugal fan discharge arrangement

Vertical arrangement unit

Horizontal arrangement unit

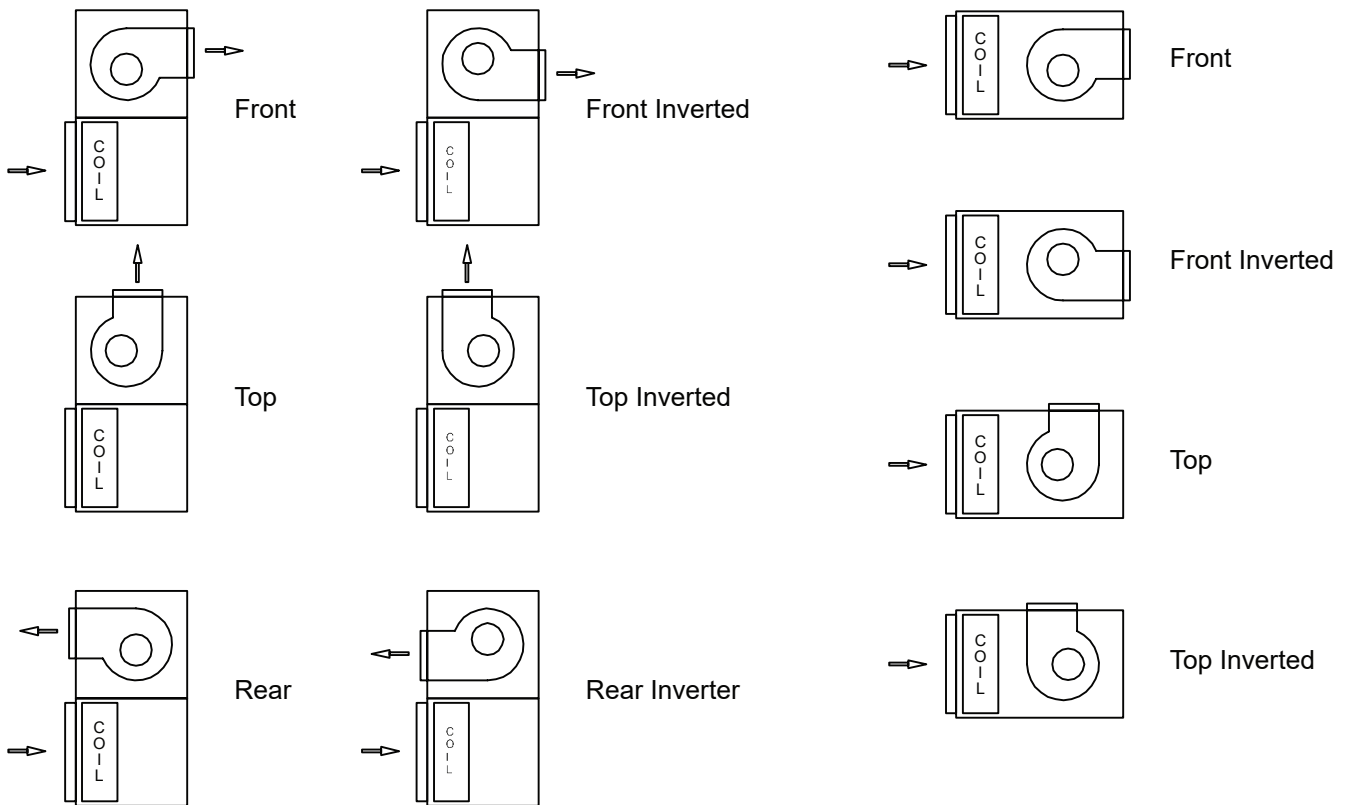



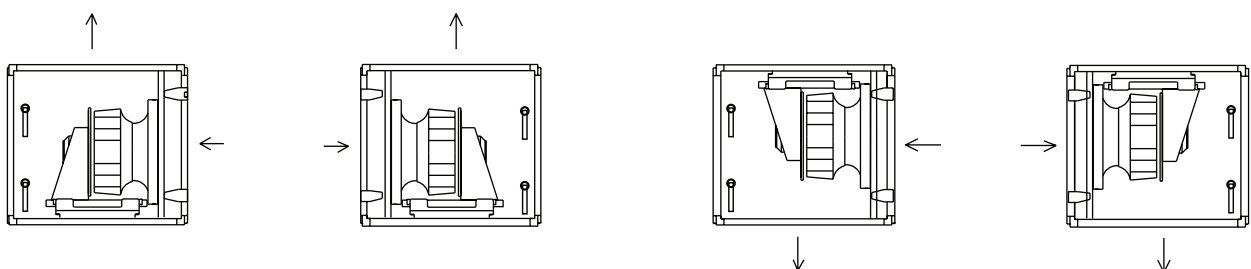



Plug fan discharge arrangement



Filter Section

Wide varieties of air filtration systems are available to choose from depending on the requirement.

Metal Pre-Filter		Pressure Drop Initial / Final 20pa 120pa	25-35%		
Primary Filtration	Medium Efficiency	Pressure Drop Initial / Final 40pa 180pa 50pa 200pa 55pa 250pa	Primary Filters	EN 779:2002 G2 ≥ 65% G3 ≥ 80% G4 ≥ 90% EN 779:2002 Average Arrestance	   
		High Efficiency	Pressure Drop Initial / Final 45pa 200pa 70pa 220pa 120pa 240pa 140pa 260pa 150pa 300pa	Fine Filters	EN 779:2002 F5 ≥ 40% F6 ≥ 60% F7 ≥ 80% F8 ≥ 90% F9 ≥ 95% EN 779:2002 Average Efficiency
Filtration for Air Conditioning Systems. Pre-Filtration for HEPA/ULPA Filters	Very High Efficiency		Initial / Final 140pa 300pa 150pa 320pa 220pa 340pa 240pa 360pa 250pa 390pa 260pa 680pa	MPPS (Most Penetrating Particle Size)	EN 1822 H10 ≥ 85% H11 ≥ 95% H12 ≥ 99,5% H13 ≥ 99,95% H14 ≥ 99,995% U15 ≥ 99,9995% U16 ≥ 99,99995% U17 ≥ 99,999995%
		Class according to Fed. Std 209E 10,000 100 to 1,000 1 to 10	HEPA ULPA	Final Filters / Clean Room Filters	
Molecular		Initial / Final 100pa 150pa 180pa 380pa	Media Activated Carbon Granule Activated Carbon	 	

Modules



UV MODULE

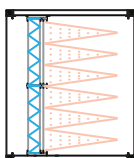

PANELS & BAGS MODULE

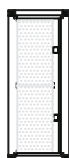

HEPA MODULE

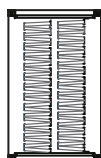

ACTIVATED CARBON MODULE

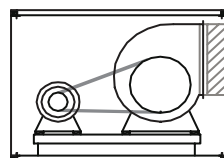

EXTRACT FAN MODULE

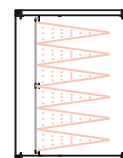









PANELS & BAGS MODULE



HEPA MODULE

Control Elements

	Function and application	Construction
Duct temperature sensor 	<ul style="list-style-type: none"> ● Measuring the temperature of supply, exhaust and outdoor air. ● Securing max. and min. supply air temperature. 	<ul style="list-style-type: none"> ● resistance measuring element installed in an aluminium bayonet probe 25cm long
Room temperature sensor 	<ul style="list-style-type: none"> ● Measuring air temperature inside a room. 	<ul style="list-style-type: none"> ● resistance measuring element installed on a printedcircuit board
Differential pressure switch 	<ul style="list-style-type: none"> ● Control of filters' contamination level in a unit – measuring the permissible difference of air pressures before and behind the filter. ● Control of the operation of a fan unit with a belt drive – signaling fan's ram effect by means of measuring pressures on the supply and exhaust side of the fan. 	<ul style="list-style-type: none"> ● a membrane coupled with levers mechanism, when an acceptable pressure difference is exceeded, the membrane warps and disconnects electrical contact (filters contamination signal or fan unit operation) ● casing: ABS
Anti-frost thermostat on air side 	<ul style="list-style-type: none"> ● Anti-frost protection of water heater: based on the measurement of minimum acceptable temperature of air going through a heater. ● When the minimum air temperature is exceeded, the signal transferred to the controller closes the air damper on air inlet, turns off the fan and opens the water valve to the max. 	<ul style="list-style-type: none"> ● measuring element: capillary with length of 2m for VS 10÷40 6m for VS 55÷650 filled with refrigerant
Electric pre-heater control thermostat 	<ul style="list-style-type: none"> ● Switching on and off the electric pre-heater equipped with MHE control system. ● In case the air temperature behind the heater drops below a set value a signal from the thermostat switches the MHE control module which heats external air. 	<ul style="list-style-type: none"> ● measuring element: capillary with length of 2m for VS 10÷40 6m for VS 55÷650 filled with refrigerant
Over-heat protection thermostat 	<ul style="list-style-type: none"> ● Over-heating protection for electric heater - switching off the heater and automatic resume once the temperature is lowered by the hysteresis value. ● The element constitutes an optional equipment of electric heater. 	<ul style="list-style-type: none"> ● bimetallic element installed inside metal casing
Carbon monoxide (CO) detector 	<ul style="list-style-type: none"> ● Indoor carbon monoxide detection. Exceeding the acceptable threshold carbon monoxide concentration activates the outputs controlling the fan's rotational speed. 	<ul style="list-style-type: none"> ● measuring element with microprocessor circuit installed inside a high rigid casing ● casing: plastic
Electric heater's control module 	<ul style="list-style-type: none"> ● Powering, protecting and smooth regulation of electric power (thermal) of multi-stage electric heaters by means of PWM (Pulse Width Modulation) signal. ● Power of the heater is controlled by means of alternate switching on and off the first stage of heating equipped with semi-conductive relays. Subsequent stages of heating are activated with the help of connectors the moment the first stage reaches its maximum power. After a subsequent stage has been activated power of the first one drops to the minimum. 	<ul style="list-style-type: none"> ● master switch – disconnecting power supply of the electric heater ● control module ● set of connectors – switching heater circuits on ● set of system switches- securingwires and receivers connected to the system against the effects of shortcuts and overloads
Frequency converter 	<ul style="list-style-type: none"> ● Smooth control of the air flow by proportional change of rotational speed of the motor – fan unit. ● Maintaining fixed AHU's operation parameters at variable ductwork's flow resistances. 	<ul style="list-style-type: none"> ● electronic circuit which enables changing voltage frequency powering motor and maintaining optimum U/f characteristics ● the circuit is installed inside a plastic casing ● fan enabling internal cooling of the unit ● control panel enabling entering the frequency converter's parameters

Optional Accessories

RADIAL FAN SECTION

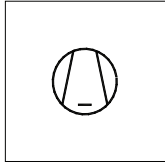

WATER HEATER SECTION

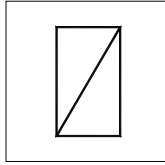

STEAM HEATER SECTION

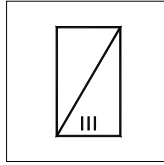

CONDENSER SECTION

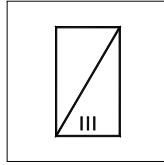

ANTI-FREEZING PROTECTION SECTION

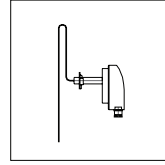

CIRCUIT SECTION: HEATING, COOLING, FIN RECUPERATION

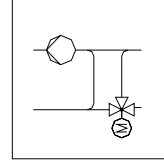

ELECTRIC HEATER SECTION

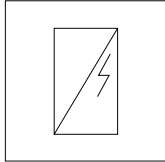

GAS HEATER SECTION

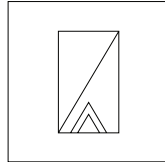

SPRAY HUMIDIFIER SECTION

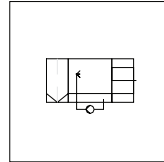

STEAM HUMIDIFIER SECTION WITH ELECTRIC STEAM GENERATOR

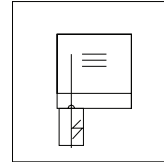

STEAM HUMIDIFIER SECTION WITH OUTSIDE STEAM SECTION

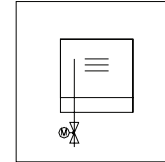

CONTACT HUMIDIFIER WITH CIRCULATING WATER SECTION

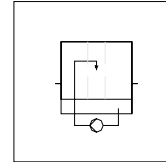

CONTACT HUMIDIFIER WITH DIRECT WATER SECTION

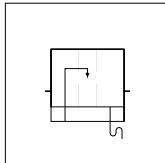

WATER COOLER SECTION

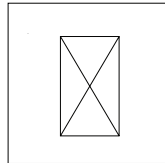

DIRECT EVAPORATOR SECTION

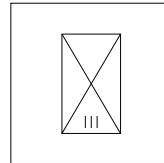

DROPLET ELIMINATOR

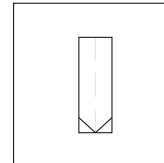

COMPRESSOR SECTION

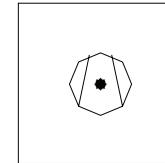

SECTION WITH ONE CONTROL DAMPER

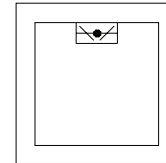

SECTION WITH TWO CONTROL DAMPERS

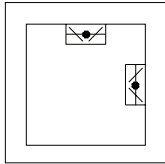

DUAL MIXING SECTION

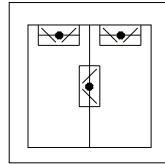

CONTROL DAMPER

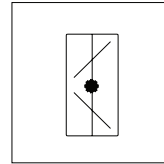

AIR-TIGHT CONTROL DAMPER

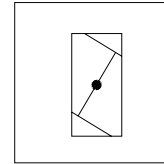

FILTRATION CLASS G3 FILTER SECTION

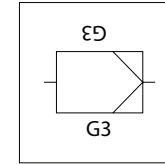

FILTRATION CLASS G4 FILTER SECTION

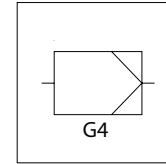

FILTRATION CLASS F5 FILTER SECTION

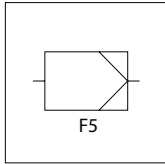

FILTRATION CLASS F6 FILTER SECTION

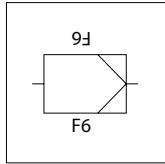

FILTRATION CLASS F7 FILTER SECTION

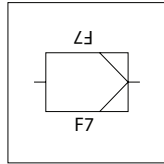

FILTRATION CLASS F9 FILTER SECTION

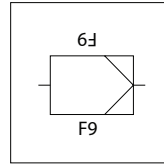

FILTRATION CLASS H10 ABSOLUTE FILTER SECTION

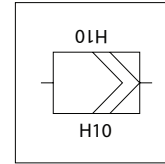

FILTRATION CLASS H11 ABSOLUTE FILTER SECTION

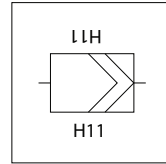

FILTRATION CLASS H12 ABSOLUTE FILTER SECTION

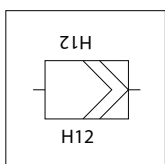

FILTRATION CLASS H13 ABSOLUTE FILTER SECTION

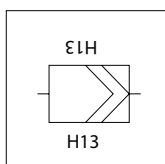

ACTIVATED CHARCOAL FILTER SECTION

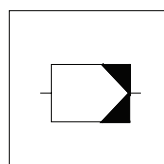

ELECTROSTATIC FILTER SECTION

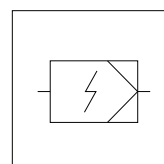

SOUND ATTENUATION SECTION

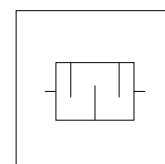

ELECTRIC CONTROL CABINET SECTION

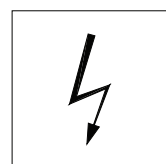

FIN RECUPERATOR SECTION - HEATING PART

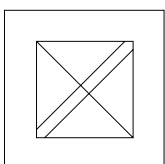

FIN RECUPERATOR SECTION - COOLING PART

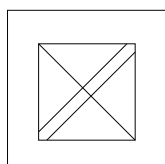

ROTARY REGENERATOR SECTION

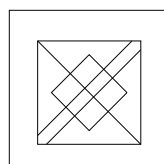

HEAT PIPE SECTION

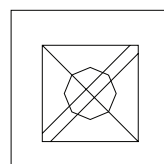

HEAT PIPE SECTION

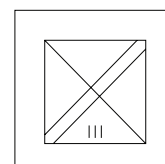

SHORT DIFFUSER SECTION

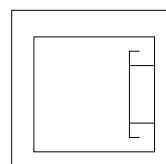

Design AHU by Software

It is now much easier to choose the convenient air-handling unit thewith help of the PAYA TAHVIEH AHU SELECTION software program designed by PAYA TAHVIEH research and development engineering department based on carrier software. The software program is an excellent and user friendly tool, helping the engineers to run previously time consuming and complicated selection procedures in only a few minutes. Also it simplifies the complexity of any given design and minimizes the time required for its selection completion.

Some of the features of the selection program are:

Size selection through face velocity of the air, Selection of cooling and heating, water or evaporator, coils with a presentation of on/off air conditions on the psychrometric chart. Using air – flow and external static pressure, the detailed drawing of in FRONT and Plan View can be appeared through some simple “clicks” of a p/c mouse, which defines the components required. Creation of detailed drawings with unit configuration, marking the components to be included from an existing list

In every project, the user can customize the general technical input such as pressure drop, outside air conditions, inside air conditions, and coil properties. This way there is no need to set the same parameters for every air-handling unit separately under the same project.



Quick Selection Chart

How to select quickly

Given:

Air flow: 15000 cfm

Coil face velocity: 500 fpm

Selection Guide

Indoor condition:

- Iran, Tehran, 4920 Ft above sea level.
- Indoor Temp. ----- 68 F
- Indoor RH ----- 50 %

Coil specification:

- Heating Load ----- 392 MBH
- Cooling Load ----- 281 MBH
- Chilled water coils @ 80/ 67°F on-coil DBT/ WBT & 45/ 55°F EWT/ LWT
- Hot water coils @70°F EAT & 180/160°F EWT/LWT

Filtration:

- Metal filter.
- Pre-filter G3
- Bag filter F7

Air flow:

- Air Delivery----- 15000 cfm.
- Return Air----- 10000 cfm.
- Fresh Air----- 5000 cfm.

Outdoor air condition:

- Summer:
- Outdoor DB----- 1000 F
- Outdoor WB----- 740 F
- Daily range----- 270 F
- Outdoor RH----- 44 %
- Winter:
- Outdoor DB----- 22 0 F
- Outdoor RH----- 15 %

Requirements:

- Unit model
- Cooling Coil specification
- Heating Coil specification
- Pressure drop
- Fan & motor Performance.
- Unit Dimension.

Selection:

Unit Model:

- Determine what is the optimum coil face velocity.

$$\text{Face Area(ft}^2\text{)} = \frac{\text{Air Delivery(CFM)}}{\text{max. Face velocity(FPM)}} = \frac{15000}{500} = 30$$

The maximum face Velocity of unit is 400-600 FPM.

The coil face area and the model of air handling unit are selected from the cooling/heating capacity table.

In the example the results are as follows:

- Model: VHA- 150
- Coil face area: 30 ft²

Cooling Coil specification:

Total cooling load is 298 MBH. Referring to cooling capacity table- chilled water for VHA- 150 the 4 rows 8 fin per inch coil have 321.1 nominal capacity.

- Cooling coil: 4 rows / 8 fin per inch

Heating Coil specification:

Total heating load is 392 MBH. Referring to heating capacity table-hot water for VHA- 150 the 1 rows 8 fin per inch coil have 427.3 MBH nominal capacity.

- Heating coil: 1 rows / 8 fin per inch

In order to determine the cooling/ heating capacity where the number of the required parameters is different from the capacity tables, use the correction factor.

Pressure drop:

Determine pressure loss of air throw each section:

$$\begin{aligned} \Delta P_{\text{Cooling coil}} &= 0.55 \text{ in. wg} & \Delta P_{\text{G3}} &= 0.1 \text{ in. wg} \\ \Delta P_{\text{Heating coil}} &= 0.4 \text{ in. wg} & \Delta P_{\text{Metal filter}} &= 0.1 \text{ in. wg} \\ \Delta P_{\text{Mixing box}} &= 0.1 \text{ in. wg} & \Delta P_{\text{Damper}} &= 0.05 \text{ in. wg} \\ \Delta P_{\text{Damper}} &= 0.05 \text{ in. wg} & \Delta P_{\text{External}} &= 1.5 \text{ in. wg} \end{aligned}$$

$$\Delta P_{\text{Total. Static}} = 3.3 \text{ in. wg}$$

Fan & motor Performance:

Air flow rat/ pressure drop is 15000 CFM/ 3.3 in. wg . Referring to fan performance table for VHA-150 the fan is selected.

- Fan and motor: Forward fan ADH- 1×710 with 711 rpm, 15 KW & 81 dB.

Unit Dimension:

Referring to dimension table-Horizontal units for VHA-150 the dimension of length, width and height are determined.

$$W \times H \times L = 1850 \times 2000 \times 4530 \text{ mm}^3$$

***Notice:** In case of limit of dimensions, it is recommended to select the vertical AHUs from its table or order L-type AHUs as an option.

Cooling capacity- Fin Spacing: 8 FPI

Model	Coil Area	Rows	Air flow rate	Chilled water coils @80/67°F On-Coil DBT / WB T & 45/55°F EWT/LWT				Direct Expansion coils @80/67°F On-Coil DBT / WB T & 45/55°F SST	
				Total Capacity (MBH)	Sensible Capacity (MBH)	Water flow rate(GPM)	pressure drop (ft.wg)	Total Capacity (MBH)	Sensible Capacity (MBH)
VHA 15	3	4	1500	41.1	27.9	8.2	7.1	46.7	29.9
		6		56.6	36.9	11.3	16.4	56.9	37
		8		61.4	40.8	12.3	4.2	61.7	40.9
30	6	4	3000	85.5	56.9	17.1	12.6	93.1	59.7
		6		109.6	72.4	21.9	9.5	113.6	73.9
		8		127.1	83.2	25.4	7.3	123.1	81.6
45	9	4	4500	96.4	67.4	19.3	3.3	116.2	74.5
		6		141.9	92.4	28.4	16.8	141.8	92.3
		8		163.9	106	32.8	12.9	153.7	101.9
60	12	4	6000	151.8	105.4	30.4	3.7	180.8	143.5
		6		222.3	144.2	44.5	18.5	220.5	158.3
		8		256.1	165.2	51.2	14.2	238.9	149.1
75	15	4	7500	251	177	50.2	17.3	232.4	184.6
		6		314.1	212.9	62.8	12.4	283.6	203.8
		8		358.6	236	71.7	9.3	307.5	186.3
100	20	4	10000	313.8	221.3	62.8	17.3	290.5	230.8
		6		392.6	266.1	78.5	12.4	354.6	254.8
		8		448.2	294.9	89.6	9.3	384.4	223.6
125	25	4	12500	340.3	252	68.1	3.9	348.6	277
		6		482.9	324.1	96.6	20.1	425.5	305.7
		8		549.8	358.9	110	15	461.2	279.5
150	30	4	15000	441.9	321.1	88.4	6.1	435.8	346.2
		6		592.9	400.8	118.6	13.7	531.8	382.1
		8		636.9	427.9	127.4	3.3	576.5	372.7
175	35	4	17500	519	375.9	103.8	6.7	508.4	403.9
		6		695.2	469	139.05	14.95	620.45	445.8
		8		747.6	501.05	149.55	3.6	672.6	419.3
200	40	4	20000	596.1	430.7	119.2	7.3	581	461.6
		6		797.4	537.2	159.5	16.2	709.1	509.5
		8		858.3	574.2	171.7	3.9	768.7	465.9
250	50	4	25000	775.7	549.9	155.1	13.3	726.3	577
		6		971.5	661.4	194.3	9.5	886.4	636.9
		8		1112	733.8	222.4	7.2	960.9	596.3
300	60	4	30000	1004	708.1	200.8	15.9	929.6	739.6
		6		1256	851.7	251.3	11.4	1134.6	5.3
		8		1434	943.8	286.8	8.5	1229.9	812
350	70	4	35000	1130	796.6	225.9	15.9	1045.8	742.5
		6		1413	958.15	282.7	11.4	1276.4	464.25
		8		1614	1061.8	322.7	8.5	1383.65	915.55
400	80	4	40000	1255	885.1	251	15.9	1162	745.4
		6		1570	1064.6	314.1	11.4	1418.2	923.2
		8		1793	1179.8	358.6	8.5	1537.4	1019.1
450	90	4	45000	1255	937.4	251.1	3.1	1307.3	838.6
		6		1794	1028.6	358.5	15.6	1595.5	1038.6
		8		2048	1340.1	409.6	11.7	1729.6	1146.4

Cooling capacity- Fin Spacing: 14 FPI

Model	Coil Area	Rows	Air flow rate	Chilled water coils @80/67°F On-Coil DBT / WB T & 45/55°F EWT/LWT				Direct Expansion coils @80/67°F) On-Coil DBT / WB T & 45/55°F SST					
				Total Capacity (MBH)	Sensible Capacity (MBH)	Water flow rate(GPM)	pressure drop (ft.wg)	Total Capacity (MBH)	Sensible Capacity (MBH)				
VHA	Ft ²	No.	CFM										
				15	3	4	1500	52.6	35.7	10.5	9.1	59.8	38.3
						6		69.1	45.0	13.8	20.0	69.4	45.1
		8		70.0	46.5	14.0	4.8	70.3	46.6				
30	6	3000	4	109.4	72.8	21.9	16.1	119.2	76.4				
			6	133.7	88.3	26.7	11.6	138.6	90.2				
			8	144.9	94.8	29.0	8.3	140.3	93.0				
45	9	4500	4	123.4	86.3	24.7	4.2	148.7	95.4				
			6	173.1	112.7	34.6	20.5	173.0	112.6				
			8	186.8	120.8	37.4	14.7	175.2	116.2				
60	12	6000	4	194.3	134.9	38.9	4.7	231.4	183.7				
			6	271.2	175.9	54.3	22.6	269.0	193.1				
			8	292.0	188.3	58.4	16.2	272.3	170.0				
75	15	7500	4	321.3	226.6	64.3	22.1	297.5	236.3				
			6	383.2	259.7	76.6	15.1	346.0	248.6				
			8	408.8	269.0	81.7	10.6	350.6	212.4				
100	20	10000	4	401.7	283.3	80.4	22.1	371.8	295.4				
			6	479.0	324.6	95.8	15.1	432.6	310.9				
			8	510.9	336.2	102.1	10.6	438.2	254.9				
125	25	12500	4	435.6	322.6	87.2	5.0	446.2	354.6				
			6	589.1	395.4	117.9	24.5	519.1	373.0				
			8	626.8	409.1	125.4	17.1	525.8	318.6				
150	30	15000	4	565.6	411.0	113.2	7.8	557.8	443.1				
			6	723.3	489.0	144.7	16.7	648.8	466.2				
			8	726.1	487.8	145.2	3.8	657.2	424.9				
175	35	17500	4	664.3	481.2	132.9	8.6	650.8	517.0				
			6	848.1	572.2	169.6	18.2	756.9	543.9				
			8	852.3	571.2	170.5	4.1	766.8	478.0				
200	40	20000	4	763.0	551.3	152.6	9.3	743.7	590.8				
			6	972.8	655.4	194.6	19.8	865.1	621.6				
			8	978.5	654.6	195.7	4.4	876.3	531.1				
250	50	25000	4	992.9	703.9	198.5	17.0	929.7	738.6				
			6	1185.2	806.9	237.0	11.6	1081.4	777.0				
			8	1267.5	836.5	253.5	8.2	1095.4	679.8				
300	60	30000	4	1285.2	906.4	257.0	20.4	1189.9	946.7				
			6	1532.7	1039.1	306.6	13.9	1384.2	6.5				
			8	1635.0	1075.9	327.0	9.7	1402.1	925.7				
350	70	35000	4	1445.9	1019.6	289.2	20.4	1338.6	950.4				
			6	1724.3	1168.9	344.9	13.9	1557.2	566.4				
			8	1839.4	1210.5	367.9	9.7	1577.4	1043.7				
400	80	40000	4	1606.5	1132.9	321.3	20.4	1487.4	954.1				
			6	1915.9	1298.8	383.2	13.9	1730.2	1126.3				
			8	2043.8	1345.0	408.8	9.7	1752.6	1161.8				
450	90	45000	4	1606.8	1199.9	321.4	4.0	1673.3	1073.4				
			6	2188.8	1254.9	437.4	19.0	1946.5	1267.1				
			8	2334.6	1527.7	466.9	13.3	1971.7	1306.9				

Heating capacity- Fin Spacing: 8 FPI

Model	Coil Area Ft ²	Rows No.	Air Flow Rate CFM	Hot water coils @70°F EAT & 180/160°F EWT/LWT			Steam coils @70°F EAT & 2psig steam pressure
				Capacity (MBH)	Water Flow Rate (GPM)	Water Pressure Drop (ft.g)	Heating Capacity (MBH)
15	3	1	1500	26.4	3.5	3.3	79.3
		2		70.3	7.1	3.1	149.0
30	6	1	3000	65.3	6.5	5.3	125.0
		2		115.1	11.5	4.15	225.5
45	9	1	4500	94.5	9.5	1.7	201.5
		2		181.3	18.2	3	318.1
60	12	1	6000	130.3	13	1.7	280.0
		2		252.7	25.3	3.3	505.0
75	15	1	7500	254.2	24.5	9.4	354.1
		2		416.6	41.7	6.9	638.7
100	20	1	10000	306.5	30.7	9.4	450.9
		2		520.7	52.1	6.9	813.3
125	25	1	12500	341.9	34.2	2.4	536.0
		2		674.4	64.4	11.45	966.8
150	30	1	15000	427.3	42.7	3.5	672
		2		828.9	82.9	16.6	1212
175	35	1	17500	502.3	50.3	3.8	784
		2		935.2	93.5	11.6	1414
200	40	1	20000	577.3	57.7	4.1	896
		2		1041.4	104.1	6.6	1616
250	50	1	25000	756.6	75.7	7.5	1120
		2		1350.5	135.1	11.8	2020
300	60	1	30000	979.1	97.9	8.2	1344
		2		1719.5	171.5	11.6	2424
350	70	1	35000	1109.5	110.9	8.8	1536
		2		1904.5	190.5	8	2770.5
400	80	1	40000	1226.2	122.6	8.8	1792
		2		2082.9	208.3	6.5	3232
450	90	1	45000	1415.6	141.6	12.1	2016
		2		2386.7	238.7	8.8	3636

Heating capacity- Fin Spacing: 14 FPI

Model	Coil Area Ft ²	Rows No.	Air Flow Rate CFM	Hot water coils @70°F EAT & 180/160°F EWT/LWT			Steam coils @70°F EAT & 2psig steam pressure
				Capacity (MBH)	Water Flow Rate (GPM)	Water Pressure Drop (ft.g)	Heating Capacity (MBH)
15	3	1	1500	46.6	5.8	5.0	114.3
		2		98.0	9.8	3.8	196.4
30	6	1	3000	74.4	7.4	6.0	142.5
		2		147.3	14.7	5.3	288.6
45	9	1	4500	102.5	10.2	2.1	218.6
		2		183.8	18.4	3.4	368.4
60	12	1	6000	134.4	13.4	2.2	286.7
		2		245.8	24.5	3.7	492.9
75	15	1	7500	148.5	14.8	1.9	319.2
		2		323.5	32.4	4.2	646.4
100	20	1	10000	310.1	29.9	11.5	432.0
		2		474.9	47.5	7.9	728.1
125	25	1	12500	392.3	39.3	12.0	577.2
		2		635.3	63.6	8.4	992.2
150	30	1	15000	389.8	39.0	2.7	611.0
		2		863.2	82.4	14.7	1237.5
175	35	1	17500	521.3	52.1	4.3	819.8
		2		944.9	94.5	18.9	1381.7
200	40	1	20000	738.9	73.9	5.2	1146.9
		2		1270.5	127.0	8.1	1971.5
250	50	1	25000	862.5	86.3	8.6	1276.8
		2		1728.6	172.9	15.1	2585.6
300	60	1	30000	1134.7	113.5	9.9	1557.7
		2		1622.6	162.3	10.5	2201.6
350	70	1	35000	1412.6	141.3	11.3	1835.0
		2		2338.1	233.8	12.5	3154.4
400	80	1	40000	1397.9	139.8	10.0	2042.9
		2		2666.1	266.6	8.3	4137.0
450	90	1	45000	1727.0	172.8	14.8	2459.5
		2		2720.8	272.1	10.0	4145.0

In order to determine the cooling/ heating capacity where the number of the required parameters is different from the capacity tables, use the correction factor as following:

Velocity correction factor						
Coil face velocity	400	450	500	550	600	700
Cooling coil	0.88	0.94	1	1.05	1.11	1.19
Heating coil	0.92	0.96	1	1.03	1.06	1.11

Capacity correction factor cooling				
No. of rows	Fin per Inch			
	8	10	12	14
4	1.00	1.10	1.19	1.29
6	1.00	1.08	1.15	1.23
8	1.00	1.06	1.10	1.15

Capacity correction factor heating				
No. of rows	Fin per Inch			
	8	10	12	14
1	1.00	1.10	1.22	1.33
2	1.00	1.08	1.17	1.25
3	1.00	1.15	1.30	1.45

Hot water correction factor				
Entering Water Temperature °F	160	180	200	220
Correction Factor	0.75	1	1.25	1.5

Chilled water correction factor				
Entering Water Temperature °F	42	44	45	46
Correction Factor	1.09	1.04	1	0.97

Design Fan by Software

When it comes to radial fans, we are the first people you should talk to. We offer the largest most comprehensive range of products in the area. That is why we are a strong provider for many optional solutions.

The technical selection program enables You to configure your own individually designed fan from the entire range of fan types and their associated options.

The result of the program is the provision of all the technical data for your fan, including sound level data, dimension specifications and accessories. Also during the fan selection process, it is possible to choose any of the standardized ATEX options.

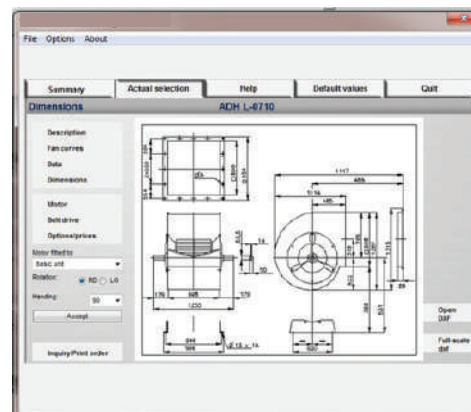
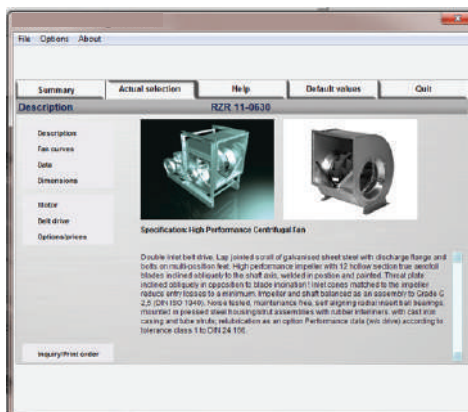
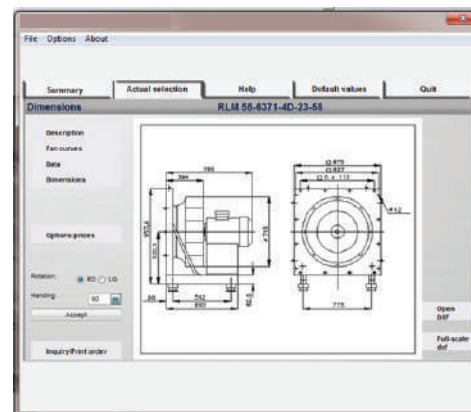
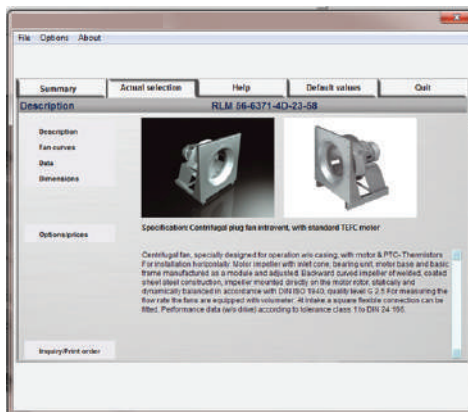
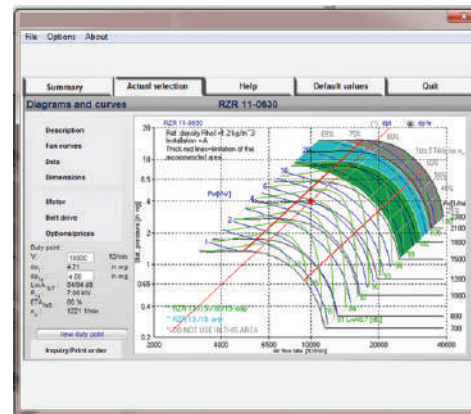
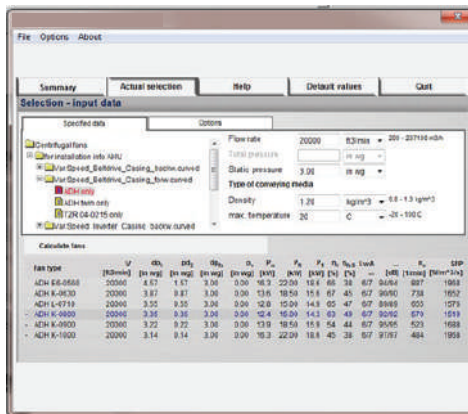
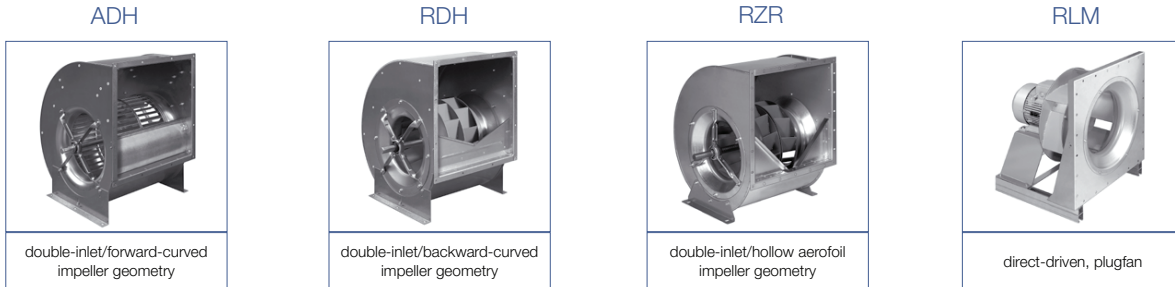

Forward Fans

Air flow	Fan model	Pressure drop (in of water gage)																				
		1			1.5			2			2.5			3			3.5			4		
CFM	ADH (mm)	RPM	KW	db	RPM	KW	db	RPM	KW	db	RPM	KW	db	RPM	KW	db	RPM	KW	db	RPM	KW	db
1500	1x250	1103	0.55	64	1345	0.75	68	-	-	-	-	-	-	-	-	-	-	-	-	-	-	-
	1x280	994	0.55	63	1219	0.75	67	-	-	-	-	-	-	-	-	-	-	-	-	-	-	-
3000	1x315	904	1.1	75	1083	77	1.5	-	-	-	-	-	-	-	-	-	-	-	-	-	-	-
	1x355	776	1.1	73	938	76	1.5	1080	2.2	79	-	-	-	-	-	-	-	-	-	-	-	-
4500	1x355	838	2.2	79	977	83	3	-	-	-	-	-	-	-	-	-	-	-	-	-	-	-
	1x400	687	1.5	72	977	79	3	958	3	79	-	-	-	-	-	-	-	-	-	-	-	-
6000	1x400	731	2.2	80	852	3	81	966	4	81	-	-	-	-	-	-	-	-	-	-	-	-
	1x450	620	2.2	76	746	3	78	861	4	80	-	-	-	-	-	-	-	-	-	-	-	-
7500	1x500	554	2.2	78	669	4	80	773	4	82	-	-	-	-	-	-	-	-	-	-	-	-
	1x560	479	2.2	75	586	3	78	680	4	80	763	5.5	83	-	-	-	-	-	-	-	-	-
10000	1x500	594	4.0	83	688	5.5	84	778	7.5	85	864	7.5	84	-	-	-	-	-	-	-	-	-
	1x560	494	3.0	79	589	4	80	676	5.5	82	756	7.5	84	830	11	85	-	-	-	-	-	-
12500	1x560	526	5.5	83	608	5.5	84	686	7.5	85	759	11	86	829	11	87	-	-	-	-	-	-
	1x630	430	4.0	78	519	5.5	81	600	7.5	83	673	11	86	741	11	88	-	-	-	-	-	-
15000	1x630	446	5.5	81	525	7.5	83	600	11	84	670	11	86	735	15	88	796	15	90	-	-	-
	1x710	386	5.5	78	464	7.5	81	534	11	84	598	11	86	657	15	89	711	15	91	-	-	-
17500	1x630	469	7.5	84	539	11	85	607	11	86	672	15	88	734	15	89	793	18.5	90	-	-	-
	1x710	398	5.5	80	470	7.5	82	536	11	84	597	15	87	654	15	89	708	18.5	91	758	18.5	93
20000	1x710	414	7.5	83	480	11	84	542	11	86	600	15	87	655	15	89	706	18.5	91	756	22	92
	1x800	340	7.5	82	405	11	84	465	11	87	519	15	89	570	15	92	617	18.5	94	662	22	96
25000	1x800	360	11.0	86	418	11	87	472	15	89	522	18.5	90	570	18.5	92	614	22	94	657	30	95
	2x560	457	4.0	83	509	5.5	83	559	5.5	84	608	7.5	84	640	7.5	84	686	7.5	85	730	11	85
30000	1x800	386	15.0	89	438	15	90	487	18.5	91	533	22	92	577	30	94	619	30	95	659	30	96
	2x560	553	7.5	87	568	7.5	87	597	7.5	87	639	11	87	667	11	88	708	11	88	748	11	88
35000	1x900	331	15.0	89	381	18.5	91	429	22	92	475	30	93	518	30	95	559	37	96	597	37	98
	2x630	455	7.5	83	469	7.5	84	526	11	85	567	11	86	607	11	86	659	11	87	697	15	88
40000	1x1000	284	15.0	88	332	18.5	90	377	22	92	420	30	93	460	30	95	499	37	97	536	45	99
	2x710	414	7.5	83	480	11	84	542	11	86	600	15	87	655	15	89	706	18.5	91	756	22	92
45000	1x1000	297	18.5	91	340	22	92	381	30	93	421	30	94	381	30	94	497	45	97	532	45	99
	2x710	434	7.5	84	501	11	85	560	11	87	620	15	87	671	15	89	724	18.5	91	768	22	92

Backward Fans

Air flow	Fan model	Pressure drop (in of water gage)																					
		1			1.5			2			2.5			3			3.5			4			
CFM	RZR (mm)	RPM	KW	db	RPM	KW	db	RPM	KW	db	RPM	KW	db	RPM	KW	db	RPM	KW	db	RPM	KW	db	
1500	1x250	2015	0.55	65	2238	0.55	66	2441	0.75	68	2631	1.1	69	2813	1.1	71	-	-	-	-	-	-	-
	1x280	1581	0.37	61	1806	0.55	63	2015	0.75	66	2214	1.1	68	2403	1.1	71	2582	1.5	73	2752	1.5	75	
	1x280	2341	1.1	75	2503	1.5	76	2650	2.2	76	2788	2.2	77	-	-	-	-	-	-	-	-	-	-
3000	1x280	1776	1.1	70	1936	1.1	71	2086	1.5	72	2228	2.2	73	2363	2.2	74	2490	2.2	74	2612	3.00	75	
	1x315	1743	1.5	74	1878	2.2	75	2002	2.2	75	2119	2.2	76	2229	3.00	76	2334	4.00	77	2434	4.00	74	
	1x400	1333	1.5	68	1468	2.2	70	1585	2.2	70	1692	2.2	71	1793	3.00	72	1890	3.00	73	1983	4.00	74	
6000	1x355	2153	3	80	2265	3.00	80	2371	4.00	81	2471	4.00	81	2567	5.5	82	2660	5.5	82	2749	5.5	72	
	1x400	1593	2.2	75	1714	3.00	75	1825	3.00	76	1925	3.00	76	2017	4.00	77	2104	5.5	77	2186	5.5	78	
	1x450	1417	3.00	75	1526	3.00	75	1624	3.00	76	1714	4.00	76	1796	5.5	77	1874	5.5	77	1947	7.5	78	
7500	1x500	1087	2.2	69	1187	3.00	70	1276	3.00	71	1359	4.00	71	1437	5.5	72	1513	5.5	73	1587	5.5	74	
	1x500	1313	3.00	76	1403	5.5	76	1484	5.5	77	1559	5.5	77	1629	5.5	77	1695	7.5	78	1758	7.5	78	
	1x560	1012	3.00	72	1100	4.00	72	1178	5.5	73	1250	5.5	73	1318	5.5	74	1383	7.5	75	1447	7.5	75	
12500	1x630	893	3.00	71	972	4.00	72	1042	5.5	72	1106	7.5	73	1167	7.5	74	1225	11.0	75	1282	11.0	75	
	1x710	697	3.00	67	772	4.00	68	840	5.5	69	905	5.5	70	967	7.5	72	1028	7.5	73	1088	11.0	75	
	1x710	773	4.00	71	845	5.5	72	908	7.5	72	966	7.5	73	1021	11.0	74	1075	11.0	75	1127	11.0	76	
15000	1x800	601	4.00	66	669	5.5	67	731	5.5	69	790	7.5	70	847	11.0	72	904	11.0	73	959	4.00	75	
	1x800	654	4.00	70	718	5.5	70	776	7.5	71	829	11.0	72	881	11.0	73	931	11.0	74	980	15.0	75	
	1x900	517	4.00	66	580	5.5	67	638	7.5	69	693	7.5	70	747	11.0	72	801	11.0	74	853	15.0	76	
20000	1x900	554	4.00	69	613	7.5	70	667	7.5	71	717	11.0	72	767	11.0	73	815	15.0	74	862	15.0	76	
	1x1000	454	4.00	65	512	5.5	67	567	7.5	69	620	11.0	71	671	11.0	73	722	15.0	75	771	15.0	77	
	1x1000	508	7.5	70	561	7.5	71	609	11.0	72	654	11.0	73	698	15.0	74	740	15.0	75	782	18.5	77	
25000	2x630	893	3.00	71	972	4.00	72	1042	5.5	72	1106	7.5	73	1167	7.5	74	1225	11.0	75	1282	11.0	75	
	1x1120	445	7.5	75	493	11.0	76	538	11.0	77	581	15	78	623	18.5	79	663	18.5	80	703	22	82	
	2x710	773	4.00	71	845	5.5	72	908	7.5	72	966	7.5	73	1021	11.0	74	1075	11.0	75	1127	11.0	76	
35000	1x1250	385	7.5	75	430	11.0	77	472	15.0	78	512	15	79	551	18.5	80	589	22	81	626	30	82	
	2x800	654	4.00	70	718	5.5	70	776	7.5	71	829	11.0	72	881	11.0	73	931	11.0	74	980	15.0	75	
	1x140	329	11.0	76	371	15.0	77	421	18.5	79	457	30	79	493	30	80	527	30	81	559	37	82	
40000	2x900	554	4.00	69	613	7.5	70	667	7.5	71	717	11.0	72	767	11.0	73	815	15.0	74	862	15.0	76	
	1x140	348	348	77	388	15.0	77	425	18.5	78	460	30	79	494	30	80	528	30	81	560	37	82	
	2x900	556	4.00	69	615	7.5	70	670	7.5	71	719	11.0	72	771	11.0	73	820	15.0	74	863	15.0	76	

Backward Fans- (Continued)

Air flow	Fan model	Pressure drop (in of water gage)																							
		4.5			5			5.5			6			6.5			7			7.5					
CFM	RZR (mm)	RPM	KW	db	RPM	KW	db	RPM	KW	db	RPM	KW	db	RPM	KW	db	RPM	KW	db	RPM	KW	db	RPM	KW	db
1500	-	-	-	-	-	-	-	-	-	-	-	-	-	-	-	-	-	-	-	-	-	-	-	-	-
	-	-	-	-	-	-	-	-	-	-	-	-	-	-	-	-	-	-	-	-	-	-	-	-	-
	-	-	-	-	-	-	-	-	-	-	-	-	-	-	-	-	-	-	-	-	-	-	-	-	-
3000	1x315	2729	3	76	2842	3	77	-	-	-	-	-	-	-	-	-	-	-	-	-	-	-	-	-	-
	1x355	2530	4	75	2624	5.5	79	-	-	-	-	-	-	-	-	-	-	-	-	-	-	-	-	-	-
	1x400	2074	4	75	2164	5.5	76	2251	5.5	77	-	-	-	-	-	-	-	-	-	-	-	-	-	-	-
6000	1x355	2834	5.5	83	2918	7.5	83	-	-	-	-	-	-	-	-	-	-	-	-	-	-	-	-	-	-
	1x400	2265	5.5	78	2341	5.5	79	2416	7.5	80	-	-	-	-	-	-	-	-	-	-	-	-	-	-	-
	1x450	2018	7.5	78	2086	7.5	79	-	-	-	-	-	-	-	-	-	-	-	-	-	-	-	-	-	-
7500	1x500	1659	7.5	75	1730	7.5	76	1800	7.5	76	1869	11	77	-	-	-	-	-	-	-	-	-	-	-	-
	1x500	1819	11	78	1878	11	77	-	-	-	-	-	-	-	-	-	-	-	-	-	-	-	-	-	-
	1x560	1509	11	76	1569	11	77	1629	11	78	1688	11	79	-	-	-	-	-	-	-	-	-	-	-	-
12500	1x630	1337	11	76	1392	11	77	-	-	-	-	-	-	-	-	-	-	-	-	-	-	-	-	-	-
	1x710	1147	11	76	1205	11	78	1262	15	79	1262	15	79	-	-	-	-	-	-	-	-	-	-	-	-
	1x710	1179	15	77	1229	15	78	1279	15	79	-	-	-	-	-	-	-	-	-	-	-	-	-	-	-
15000	1x800	1013	15	77	1067	15	78	1119	15	80	1169	18.5	81	-	-	-	-	-	-	-	-	-	-	-	-
	1x800	1029	15	76	1077	15	78	1124	18.5	79	1171	18.5	80	-	-	-	-	-	-	-	-	-	-	-	-
	1x900	903	15	78	953	15	80	1000	18.5	81	1046	18.5	82	1090	22	84	-	-	-	-	-	-	-	-	-
20000	1x900	908	15	77	954	18.5	79	999	18.5	80	1043	22	82	1086	30	83	1128	30	84	-	-	-	-	-	-
	1x1000	818	18.5	79	864	18.5	81	907	22	82	949	22	84	988	30	85	1026	30	86	-	-	-	-	-	-
	1x1000	824	18.5	78	865	22	80	905	30	81	944	30	82	983	30	84	1020	30	85	1057	37	86	-	-	-
25000	2x630	1337	11	76	1392	11	77	-	-	-	-	-	-	-	-	-	-	-	-	-	-	-	-	-	-
	1x1120	742	30	80	779	30	81	816	30	86	852	37	87	886	37	88	919	45	89	952	45	90	-	-	-
	2x710	1179	15	77	1229	15	78	1279	15	79	-	-	-	-	-	-	-	-	-	-	-	-	-	-	-
35000	1x1250	662	30	86	697	37	87	730	37	88	763	45	89	794	45	90	824	45	91	853	55	92	-	-	-
	2x800	1029	15	76	1077	15	78	1124	18.5	79	1171	18.5	80	-	-	-	-	-	-	-	-	-	-	-	-
	2x900	908	15	77	954	18.5	79	999	18.5	80	1043	22	82	1086	30	83	1128	30	84	-	-	-	-	-	-
40000	1x1400	592	37	87	622	45	88	652	45	90	681	45	90	709	45	91	736	155	93	761	155	93	-	-	-
	2x900	910	18.5	77	956	18.5	79	1002	18.5	80	1048	22	82	1100	30	83	1140	30	84	-	-	-	-	-	-
	1x1400	590	37	88	622	45	89	652	45	90	681	45	91	709	45	92	736	75	93	761	75	94	-	-	-

Plug fan

Air flow	Fan model	Pressure drop (in of water gage)																							
		1			1.5			2			2.5			3			3.5			4.5					
		RPM	KW	db	RPM	KW	db	RPM	KW	db	RPM	KW	db	RPM	KW	db	RPM	KW	db	RPM	KW	db			
1500	1x31	2016	0.55	65	2201	0.55	66	2379	0.55	68	2548	1.1	70	2710	1.1	72	-	-	-	-	-	-	-		
3000	1x40	1874	1.1	72	1994	1.1	72	2110	1.5	73	2222	1.5	73	2331	2.2	74	2437	2.2	75	2541	3	76			
4500	1x560	1097	1.5	68	1202	1.5	69	1304	2.2	71	1400	2.2	73	-	-	-	-	-	-	-	-	-	-		
6000	1x630	1002	2.2	69	1091	2.2	70	1178	2.2	71	1262	3	73	1343	4	75	-	-	-	-	-	-	-		
7500	1x710	905	3	70	985	3	71	1062	3	72	1137	4	74	1209	4	76	1279	5.5	78	1346	5.5	79			
10000	1x710	1111	4	77	1172	4	77	1233	5.5	77	1293	5.5	78	1352	7.5	79	1400	7.5	80	1460	7.5	81			
12500	1x900	732	4	73	7696	4	74	857	5.5	75	916	5.5	76	973	7.5	77	1028	7.5	79	1081	11	81			
15000	1x1000	652	5.5	73	712	5.5	74	769	5.5	76	823	7.5	78	876	11	79	926	11	80	975	11	81			
17500	1x1100	551	11	72	608	11	74	661	11	76	712	11	78	761	11	80	808	11	82	852	15	83			
20000	1x1100	598	11	75	649	11	76	698	11	77	745	11	79	791	11	80	834	15	82	876	15	83			
25000	1x1100	701	11	82	743	11	81	784	11	82	824	15	82	863	15	83	901	18.5	83	939	18.5	84			
30000	1x1200	611	15	81	650	15	81	687	15	82	725	15	82	761	18.5	83	796	18.5	84	830	22	85			
35000	1x1200	688	15	86	722	15	85	755	18.5	85	788	18.5	86	820	22	86	851	30	87	882	30	87			
40000	1x1400	571	30	85	604	30	84	636	30	84	668	30	85	698	30	85	728	30	86	758	30	87			
45000	1x1400	627	30	87	656	30	87	685	30	87	714	30	87	742	30	88	769	30	87	797	37	89			

Dimensions table- Horizontal air handling unit

Model (VHA)	Mixing Box (L ₁)	SpecialFilter (L ₂)	Coil Section (L ₃)	Fan Section (L ₄)	Width (W)	Height (H)
15	800	400 + SF	600	1150	800	1000
30	880	400 + SF	600	1180	1250	1000
45	920	400 + SF	600	1180	1250	1350
60	980	400 + SF	600	1220	1250	1350
75	1170	400 + SF	600	1350	1300	1400
100	1170	400 + SF	600	1400	1850	1400
125	1240	400 + SF	600	1400	1850	1400
150	1370	400 + SF	600	1640	1850	2000
175	1440	400 + SF	600	1760	1850	2000
200	1520	400 + SF	600	1760	2450	2000
250	1240	400 + SF	600	1400	3800	1400
300	1370	400 + SF	600	1640	3800	2000
350	1440	400 + SF	600	1760	3800	2000
400	1520	400 + SF	600	1760	4500	2000
450	1540	400 + SF	600	1800	4000	2450

* All dimensions are in mm.

Dimension of special filters

Special Filter	Metal Filter	Pre-Filter		Bag Filter				Hepa Filter					Ulpa Filter			Carbon active		
		Alu.	G3	G4	F6	F7	F8	F9	H10	H11	H12	H13	H14	U15	U16	U17	Pleated Media	Granule
SF (mm)	50	50	50	300	300	300	300	150	150	150	150	150	150	150	150	150	50	25
	90	90	90	600	600	600	600	300	300	300	300	300	300	300	300	300	90	-

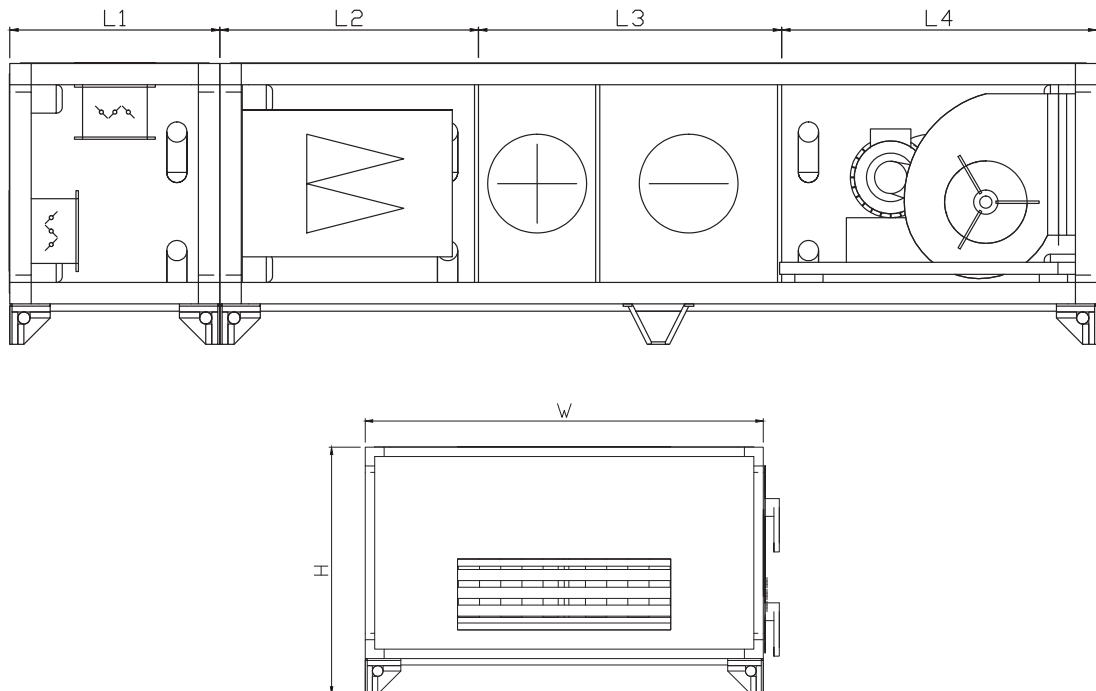

Dimensions table- L- Type air handling unit

Model (VLA)	Mixing Box (L ₁)	Special Filter (L ₂)	Coil Section (L ₃)	Fan Section (L ₄)	Width (W)	Height (H)
15	800	400 + SF	600	1150	800	2000
30	880	400 + SF	600	1180	1250	2000
45	920	400 + SF	600	1180	1250	2700
60	980	400 + SF	600	1220	1250	27000
75	1170	400 + SF	600	1350	1300	2800
100	1170	400 + SF	600	1400	1850	2800
125	1240	400 + SF	600	1400	1850	2800
150	1370	400 + SF	600	1640	1850	4000
175	1440	400 + SF	600	1760	1850	4000
200	1520	400 + SF	600	1760	2450	4000
250	1240	400 + SF	600	1400	3800	2800
300	1370	400 + SF	600	1640	3800	4000
350	1440	400 + SF	600	1760	3800	4000
400	1520	400 + SF	600	1760	4500	4000
450	1540	400 + SF	600	1800	4000	49000

* All dimensions are in mm.

Dimension of special filters

Special Filter	Metal Filter	Pre Filter		Bag Filter				Hepa Filter					Ulpa Filter			Carbon active		
		Alu.	G3	G4	F6	F7	F8	F9	H10	H11	H12	H13	H14	U15	U16	U17	Pleated Media	Granule
SF (mm)	50	50	50	300	300	300	300	150	150	150	150	150	150	150	150	150	50	25
	90	90	90	600	600	600	600	300	300	300	300	300	300	300	300	300	90	-

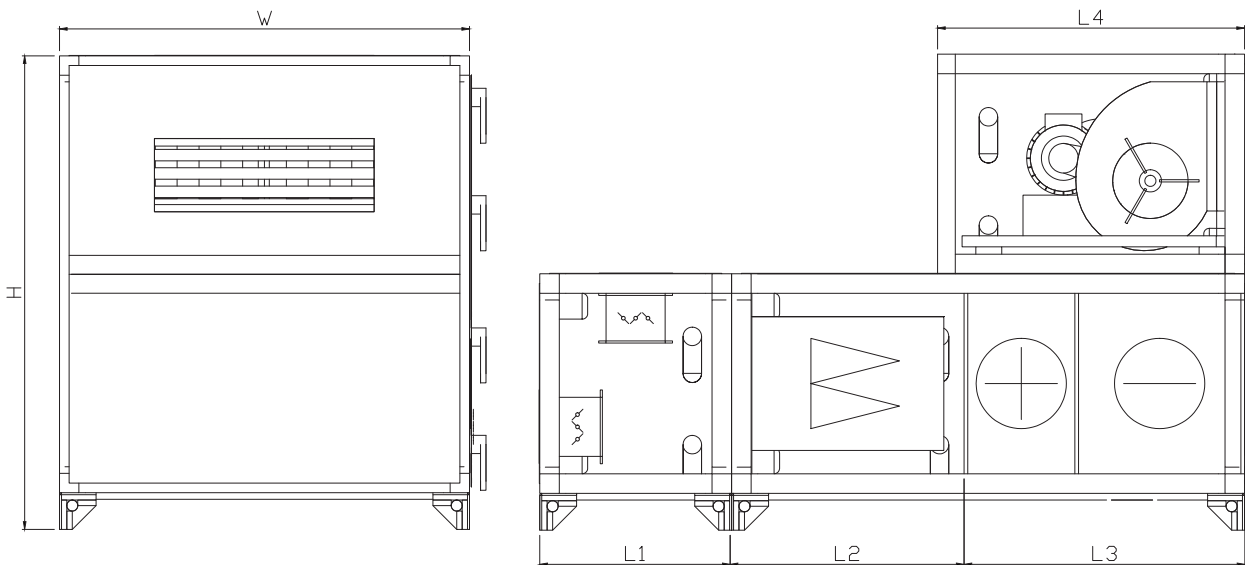

Dimensions table- Multi zone air handling unit

Model (VMA)	Mixing Box (L ₁)	Special Filter (L ₂)	Fan Section (L ₃)	Multi zone (L ₄)	Width (W)	Height (H ₁)	Height (H ₂)
15	800	400 + SF	1150	1100	800	1000	1400
30	880	400 + SF	1180	1250	1250	1000	1400
45	920	400 + SF	1180	1250	1250	1350	1750
60	980	400 + SF	1220	1400	1250	1350	1750
75	1170	400 + SF	1350	1500	1300	1400	1800
100	1170	400 + SF	1400	1550	1850	1400	1800
125	1240	400 + SF	1400	1650	1850	1400	1800
150	1370	400 + SF	1640	1850	1850	2000	2400
175	1440	400 + SF	1760	2000	1850	2000	2400
200	1520	400 + SF	1760	2000	2450	2000	2400
250	1240	400 + SF	1400	1650	3800	1400	1800
300	1370	400 + SF	1640	1850	3800	2000	2400
350	1440	400 + SF	1760	2000	3800	2000	2400
400	1520	400 + SF	1760	2000	4500	2000	2400
450	1540	400 + SF	1800	2400	4000	2450	2850

* All dimensions are in mm.

Dimension of special filters

Special Filter	Metal Filter	Pre-Filter		Bag Filter				Hepa Filter					Ulpa Filter			Carbon active		
		Alu.	G3	G4	F6	F7	F8	F9	H10	H11	H12	H13	H14	U15	U16	U17	Pleated Media	Granule
SF (mm)	50	50	50	300	300	300	300	150	150	150	150	150	150	150	150	150	50	25
	90	90	90	600	600	600	600	300	300	300	300	300	300	300	300	300	90	-

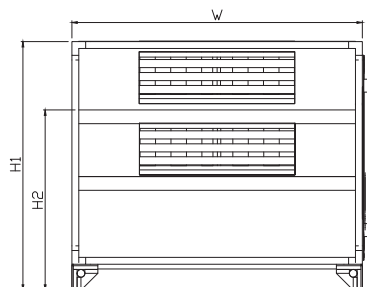
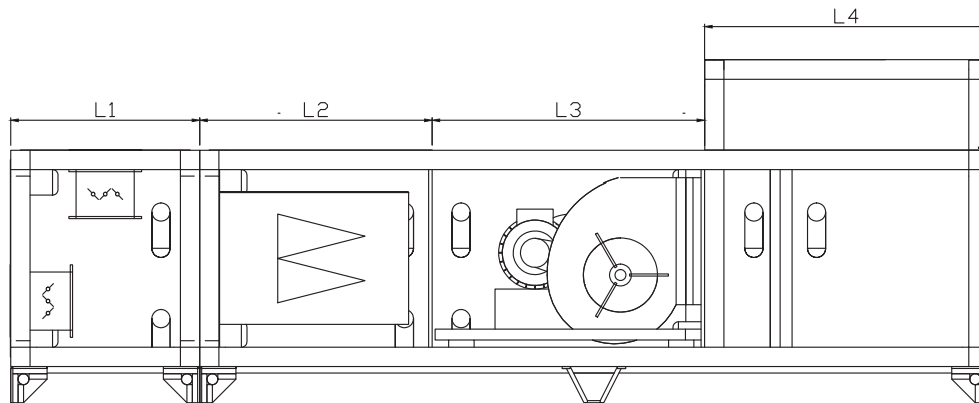

Vertical air handling unit

Model (AVV)	L	W	H ₁	H ₂	H ₃	H
15	1000	800	600	700	80	1380
0	1200	1000	800	800	80	1680
45	1200	1000	900	900	80	1880
0	1400	1150	950	1000	100	2050
75	1600	1200	1000	1100	100	2200
100	2000	1300	1200	1100	100	2400
125	200	1300	1650	1200	120	2970
150	2450	1450	1700	1200	120	3020
175	2450	1450	1750	1400	120	3270
200	2450	1600	1800	1400	120	3320
250	2700	1600	1900	1100	140	3140
300	3200	1800	1950	1200	140	3290
350	3700	1800	2000	1400	140	3540
400	4100	2000	2050	1400	140	3590
450	4600	2000	2200	1550	140	3890

*All dimensions are in mm.

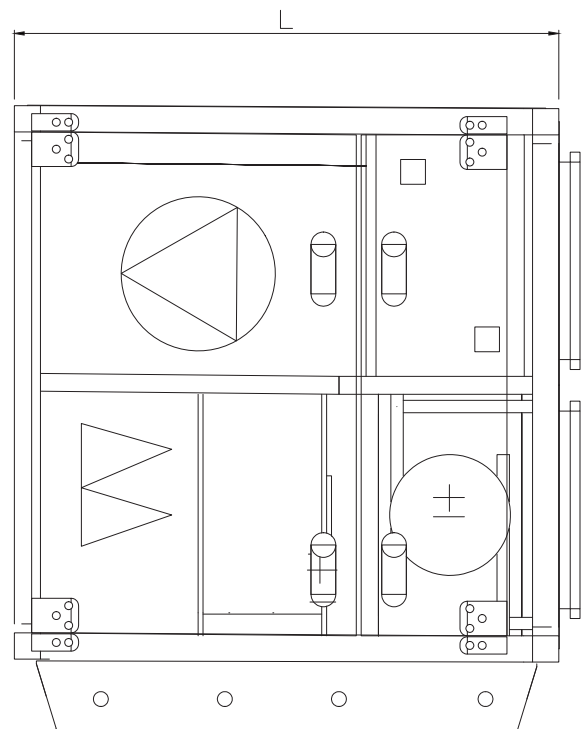
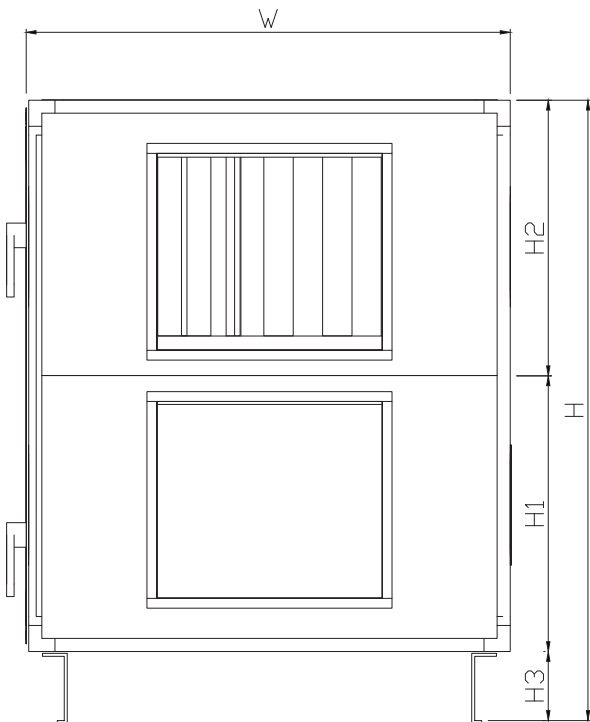



Office Room:

- +98 21 88936108
- +98 21 88809126
- www.payatahvieh.com
- info@payatahvieh.com
- Unit 15, 3dr Floor, No. 441
Erfan Bldg, N Felestin st
Fatemi Sq

Show Room:

- +98 21 77657290
- +98 21 77522584
- www.vcsanat.org
- info@vcsanat.com
- No.19, Osanloo St.,Safi
Alishah Picheshemiran

Factory and warehouse:

- +98 21 56230061
+98 21 56236456
- +98 21 56230062
- Shams Abad Industrial
Town, Bustan Blvd., Golban
19, No. 20